



USER MANUAL

WB2100

Click a topic

This user manual includes detailed usage instructions for your camera. Please read this manual thoroughly.

Basic troubleshooting	Quick reference	Contents
Basic functions	Extended functions	Shooting options
Playback/Editing	Settings	Appendixes
Index		

Health and safety information

Always comply with the following precautions and usage tips to avoid dangerous situations and ensure peak performance of your camera.



Warning—situations that could cause injury to yourself or others

Do not disassemble or attempt to repair your camera.

This may result in electric shock or damage to the camera.

Do not use your camera near flammable or explosive gases and liquids.

This may cause a fire or explosion.

Do not insert flammable materials into the camera or store these materials near the camera.

This may cause a fire or electric shock.

Do not handle your camera with wet hands.

This may result in electric shock.

Prevent damage to subjects' eyesight.

Do not use the flash in close proximity (closer than 1 m/3 ft) to people or animals. If you use the flash too close to your subject's eyes, this can cause temporary or permanent eyesight damage.

Keep your camera away from small children and pets.

Keep your camera and all accessories out of the reach of small children and animals. Small parts may cause choking or serious injury if swallowed. Moving parts and accessories may present physical dangers as well.

Do not expose the camera to direct sunlight or high temperatures for an extended period of time.

Prolonged exposure to sunlight or extreme temperatures can cause permanent damage to your camera's internal components.

Avoid covering the camera or charger with blankets or clothes.

The camera may overheat, which may distort the camera or cause a fire.

Do not handle the power supply cord or go near the charger during a thunderstorm.

This may result in electric shock.

If liquid or foreign objects enter your camera, immediately disconnect all power sources, such as the battery or charger, and then contact a Samsung service center.



Caution—situations that could cause damage to your camera or other equipment

Remove the batteries from your camera when storing it for an extended period of time.

Installed batteries may leak or corrode over time and cause serious damage to your camera.

Use only authentic, manufacturer-recommended, Lithium-ion replacement batteries. Do not damage or heat the battery.

Inauthentic, damaged, or heated batteries may cause a fire or personal injury.

Use only Samsung-approved batteries, chargers, cables and accessories.

- Using unauthorized batteries, chargers, cables or accessories can cause batteries to explode, damage your camera, or cause injury.
- Samsung is not responsible for damage or injuries caused by unapproved batteries, chargers, cables or accessories.

Use the battery only for its intended purpose.

Misusing the battery may cause a fire or electric shock.

Do not touch the flash while it fires.

The flash is very hot when fired and may burn your skin.

When you use the AC charger, turn off the camera before you disconnect the power to the AC charger.

Failing to do so may result in fire or electric shock.

Disconnect the charger from the wall socket when not in use.

Failing to do so may result in fire or electric shock.

Do not use a damaged power supply cord, plug, or loose outlet when you charge batteries.

This may cause a fire or electric shock.

Do not allow the AC charger to come in contact with the +/- terminals on the battery.

This may cause a fire or electric shock.

Do not drop or subject the camera to strong impacts.

Doing so may damage the screen or external or internal components.

Exercise caution when you connect cables or adapters and install batteries and memory cards.

If you force the connectors, improperly connect cables, or improperly install batteries and memory cards, you can damage ports, connectors, and accessories.

Keep cards with magnetic strips away from the camera case.

Information stored on the card may be damaged or erased.

Never use a damaged charger, battery, or memory card.

This may result in electric shock or camera malfunction or cause a fire.

Do not place the camera in or near magnetic fields.

Doing so may cause the camera to malfunction.

Do not use the camera if the screen is damaged.

If the glass or acrylic parts are broken, visit a Samsung Electronics Service Center to have the camera repaired.

Check that the camera is operating properly before use.

The manufacturer takes no responsibility for any loss of files or damage that may result from camera malfunction or improper use.

You must plug the small end of the USB cable into your camera.

If the cable is reversed, it may damage your files.

The manufacturer is not responsible for any loss of data.

Copyright information

- Microsoft Windows and the Windows logo are registered trademarks of the Microsoft Corporation.
- Mac and Apple App Store are registered trademarks of the Apple Corporation.
- HDMI, the HDMI logo and the term "High Definition Multimedia Interface" are trademarks or registered trademarks of HDMI Licensing LLC.
- Trademarks and trade names used in this manual are the property of their respective owners.







- Camera specifications or contents of this manual may be changed without prior notice due to upgrade of camera functions.
- We recommend using your camera within the country where you purchased.
- Use this camera responsibly and adhere to all laws and regulations concerning its use.
- You are not allowed to reuse or distribute any part of this manual without prior permission.

Outline of the User Manual

Basic functions	13
Learn about your camera's layout, icons, and basic functions for shooting.	
Extended functions	39
Learn how to capture a photo and record a video by selecting a mode.	
Shooting options	55
Learn how to set the options in Shooting mode.	
Playback/Editing	80
Learn how to play back photos or videos, and edit photos or videos. Also, learn how to connect your camera to your computer or TV.	
Settings	104
Refer to options to configure your camera's settings.	
Appendixes	110
Get information about error messages, specifications, and maintenance.	

Indicators used in this manual

Shooting mode	Indicator
Smart Auto	
Program	P
Manual	M
Scene	SCN
Panorama	
Magic Plus	
Settings	
Movie	

Shooting mode icons

These icons appear in the text when a function is available in a mode. See the example below.

Note: The SCN or  mode may not support functions for all scenes or modes.

For example:

Adjusting the exposure manually (EV) 



Depending on the intensity of the ambient light, your photos may be too bright or dark. In these cases, you can adjust the exposure to get a better photo.



▲ Darker (-) ▲ Neutral (0) ▲ Brighter (+)

Available in Program and Movie modes

Icons used in this manual

Icon	Function
	Additional information
	Safety warnings and precautions
[]	Camera buttons. For example, [Shutter] represents the shutter button.
()	Page number of related information
→	The order of options or menus you must select to perform a step; for example: Select Face Detection → Normal (represents Select Face Detection , and then select Normal).
*	Annotation

Expressions used in this manual

Pressing the shutter

- Half-press [**Shutter**]: Press the shutter halfway down
- Press [**Shutter**]: Press the shutter all the way down

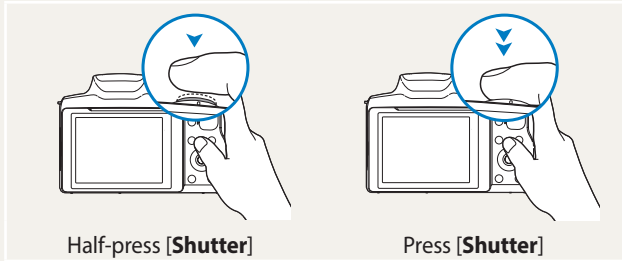

Subject, background, and composition

- **Subject:** The main object in a scene, such as a person, animal, or still life
- **Background:** The objects around the subject
- **Composition:** The combination of a subject and background

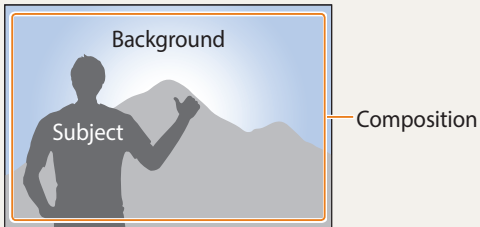

Exposure (Brightness)

The amount of light that enters your camera determines the exposure. You can alter the exposure by changing the shutter speed, aperture value, or ISO sensitivity. By altering the exposure, your photos will be darker or lighter.





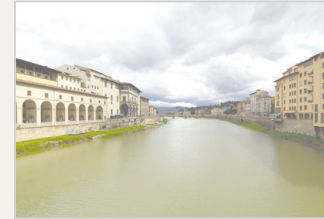







▲ Normal exposure



▲ Overexposure (too bright)

Basic troubleshooting

Learn to solve common problems by setting shooting options.

	The subject's eyes appear red.	<p>Red eye occurs when the subject's eyes reflect light from the camera flash.</p> <ul style="list-style-type: none">• Set the flash option to  Red-eye or  Red-eye Fix. (p. 59)• If the photo has already been captured, select  Red-eye Fix in the edit menu. (p. 94)
	Photos have dust spots.	<p>If dust particles are present in the air, you may capture them in photos when you use the flash.</p> <ul style="list-style-type: none">• Turn off the flash or avoid capturing photos in a dusty place.• Set ISO sensitivity options. (p. 62)
	Photos are blurred.	<p>Blurring can occur if you capture photos in low light conditions or hold the camera incorrectly. Use the OIS function or half-press [Shutter] to ensure the subject is in focus. (p. 37)</p>
	Photos are blurred when shooting at night.	<p>As the camera tries to let in more light, the shutter speed slows. This can make it difficult to hold the camera steady long enough to capture a clear photo and may result in camera shake.</p> <ul style="list-style-type: none">• Select Night in SCN mode. (p. 44)• Turn on the flash. (p. 60)• Set ISO sensitivity options. (p. 62)• Use a tripod to prevent your camera from shaking.
	Subjects come out too dark because of backlighting.	<p>When the light source is behind the subject or when there is a high contrast between light and dark areas, the subject may appear too dark.</p> <ul style="list-style-type: none">• Avoid shooting toward the sun.• Select Backlight in SCN mode. (p. 44)• Set the flash option to  Fill in. (p. 60)• Adjust the exposure. (p. 70)• Set the Auto Contrast Balance (ACB) option. (p. 71)• Set the metering option to  Spot if a subject is in the center of the frame. (p. 72)

Quick reference



Capturing photos of people

- Red-eye/Red-eye Fix (to prevent or correct red-eye) ▶ 59
- Face Detection ▶ 67



Capturing photos at night or in the dark

- SCN mode > Night, Sunset, Dawn ▶ 44
- Flash options ▶ 60
- ISO sensitivity (to adjust the sensitivity to light) ▶ 62



Capturing action photos

- Continuous ▶ 75
- Precapture ▶ 76



Capturing photos of text, insects, or flowers

- SCN mode > Close up, Text ▶ 44
- Macro ▶ 63



Adjusting the exposure (brightness)

- mode > HDR ▶ 47
- ISO sensitivity (to adjust the sensitivity to light) ▶ 62
- EV (to adjust exposure) ▶ 70
- ACB (to compensate for subjects against bright backgrounds) ▶ 71
- Metering ▶ 72
- AE Bracket (to capture 3 photos with different exposures) ▶ 76
- WB Bracket (to capture 3 photos with different white balance) ▶ 76



Capturing photos of scenery

- SCN mode > Landscape ▶ 44
- mode ▶ 45



Applying effects to photos

- mode > Split Shot ▶ 48
- mode > Photo Filter ▶ 49
- Image Adjust (to adjust Sharpness, Contrast, or Saturation) ▶ 78



Applying effects to videos

- mode > Movie Filter ▶ 50



Reducing camera shake

- Optical Image Stabilization (OIS) ▶ 36

- Viewing files as thumbnails ▶ 82
- Viewing files by category ▶ 83
- Deleting all files on the memory ▶ 86
- Viewing files as a slide show ▶ 88
- Viewing files on a TV or HDTV ▶ 95
- Connecting your camera to a computer ▶ 97
- Adjusting sound and volume ▶ 106
- Adjusting the brightness of the display ▶ 107
- Changing the display language ▶ 108
- Setting the date and time ▶ 108
- Before contacting a service center ▶ 122

Contents

Basic functions	13	Using the Mode screen	26
Unpacking	14	Selecting a Mode Screen	26
Camera layout	15	Icons on the Mode screen	27
Using the screen	18	Selecting options or menus	28
Attaching a strap	19	Using [MENU]	28
Attaching a lens cap	19	Using [Fn]	30
Inserting the battery and memory card	20	Setting the display and sound	31
Charging the battery and turning on your camera	21	Setting the display type	31
Charging the battery	21	Setting the sound	32
Turning on your camera	21	Capturing photos	33
Performing the initial setup	22	Zooming	34
Learning icons	24	Reducing camera shake (OIS)	36
		Tips for getting a clearer photo	37

Extended functions	39
Using the Smart Auto mode	40
Using the Program mode	42
Using the Manual mode	43
Using the Scene mode	44
Using the Panorama mode	45
Using the Magic Plus mode	47
Using the Low Light Shot mode	47
Using the HDR mode	47
Using the Split Shot mode	48
Using the Photo Filter mode	49
Using the Movie Filter mode	50
Using the Movie mode	51
Recording high-speed videos	53
Using the Smart Scene Detection mode	54

Shooting options	55
Selecting a resolution and quality	56
Selecting a resolution	56
Selecting an image quality	57
Using the timer	58
Shooting in the dark	59
Preventing red-eye	59
How to use the flash	59
Using the flash	60
Adjusting the ISO sensitivity	62
Changing the camera's focus	63
Using macro	63
Changing the focus option	63
Adjusting the focus area	64

Using Face Detection	67
Detecting faces	67
Capturing a self portrait shot	67
Capturing a smile shot	68
Detecting eye blinking	68
Tips for detecting faces	69
Adjusting brightness and color	70
Adjusting the exposure manually (EV)	70
Locking the exposure value (AEL)	71
Compensating for backlighting (ACB)	71
Changing the metering option	72
Selecting a White Balance setting	72
Using burst modes (Continuous/Precapture/Bracket)	75
Capturing continuous photos	75
Capturing photos in the Precapture mode	76
Capturing bracketed photos	76
Adjusting images	78
Reducing the sound of the zoom	79

Playback/Editing	80
Viewing photos or videos in Playback mode	81
Starting Playback mode	81
Viewing photos	86
Playing a video	89
Editing a photo	91
Resizing photos	91
Rotating a photo	91
Applying Smart Filter effects	92
Adjusting your photos	93
Viewing files on a TV or HDTV	95
Transferring files to the computer	97
Transferring files to your Windows OS computer	97
Transferring files to your Mac OS computer	98
Using programs on the computer	99
Installing i-Launcher	99
Using i-Launcher	100

Settings	104
Settings menu	105
Accessing the settings menu	105
Sound	106
Display	106
Connectivity	107
General	108

Appendixes	110
Error messages	111
Camera maintenance	112
Cleaning your camera	112
Using or storing the camera	113
About memory cards	115
About the battery	118
Before contacting a service center	122
Camera specifications	125
Glossary	129
FCC notice	134
Index	135

Basic functions

Learn about your camera's layout, icons, and basic functions for shooting.

Unpacking	14	Selecting options or menus	28
Camera layout	15	Using [MENU]	28
Using the screen	18	Using [Fn]	30
Attaching a strap	19	Setting the display and sound	31
Attaching a lens cap	19	Setting the display type	31
Inserting the battery and memory card	20	Setting the sound	32
Charging the battery and turning on your camera	21	Capturing photos	33
Charging the battery	21	Zooming	34
Turning on your camera	21	Reducing camera shake (OIS)	36
Performing the initial setup	22	Tips for getting a clearer photo	37
Learning icons	24		
Using the Mode screen	26		
Selecting a Mode Screen	26		
Icons on the Mode screen	27		

Unpacking

The following items are included in your product box.



Camera



AC adapter/USB cable

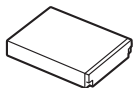

Rechargeable battery

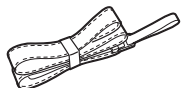

Strap



Lens cap/Lens cap strap

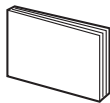

Quick Start Guide

Optional accessories



Camera case

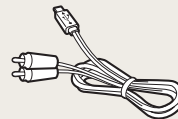

A/V cable

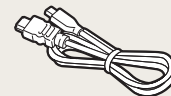

HDMI cable

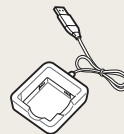

Battery charger



Memory card



Memory card/
Memory card adapter



- The illustrations may differ slightly from the items shipped with your product.
- The items included in the box may differ depending on the model.
- You can purchase optional accessories at a retailer or a Samsung service center. Samsung is not responsible for any problems caused by using unauthorized accessories.





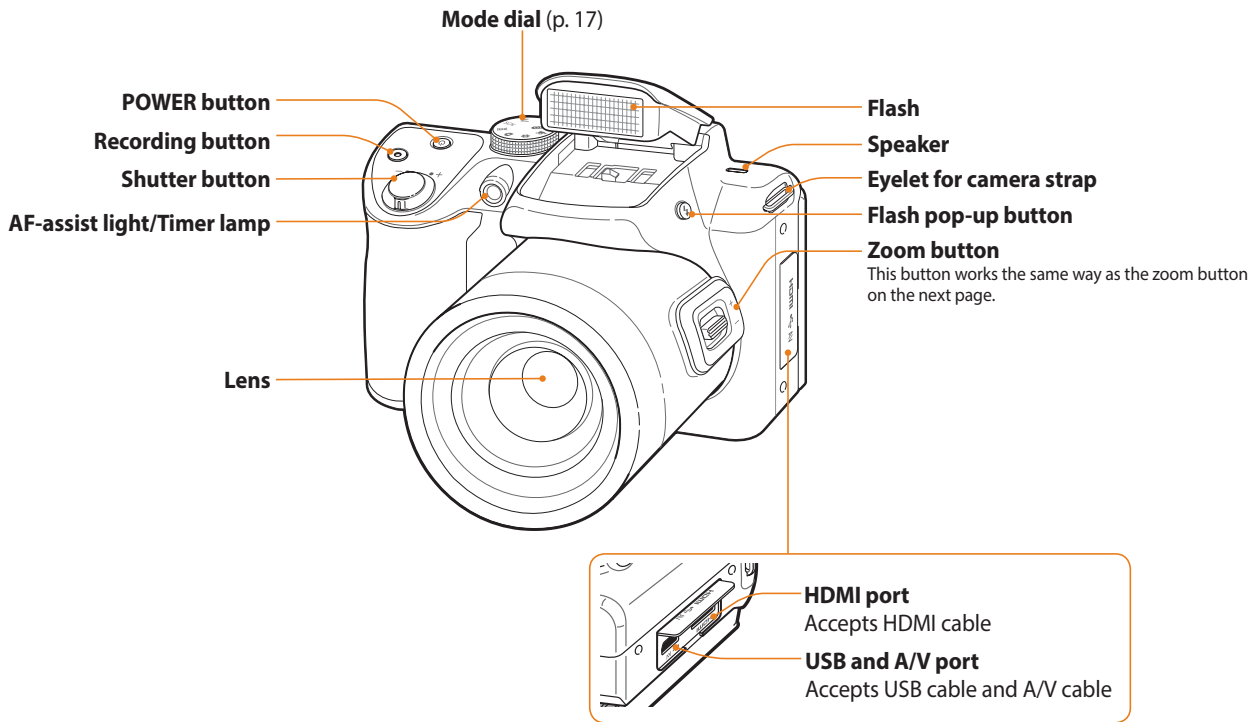

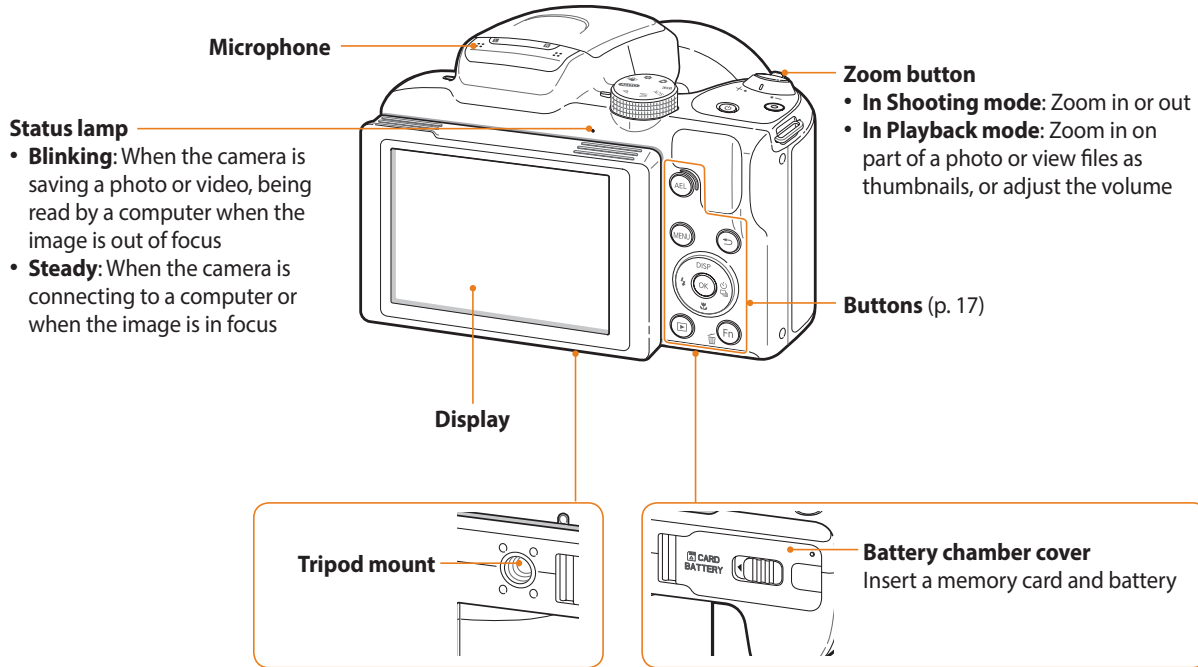

Camera layout

Before you start, familiarize yourself with your camera's parts and their functions.















Mode dial

Icon	Description
	Smart Auto: Capture a photo with a scene mode selected automatically by the camera.
	Program: Capture a photo by setting options except the shutter speed and aperture value which the camera sets automatically.
	Manual: Adjust various camera settings including shutter speed and aperture value.
	Scene: Capture a photo with options preset for a specific scene.
	Panorama: Capture and combine a series of photos to create a panoramic image.
	Magic Plus: Capture a photo with various effects.
	Settings: Adjust settings to match your preferences.
	Movie: Customize settings to record a video.

Buttons

Button	Description		
	Lock the adjusted exposure value in Shooting mode.		
	Access options or menus.		
	Move back.		
	Basic functions	Other functions	
	 DISP	Change the display option.	Move up
		Change the macro option.	Move down
		Change the flash option.	Move left
		Change the timer and burst options.	Move right
	Confirm the highlighted option or menu.		
	Enter Playback mode.		
	<ul style="list-style-type: none"> • Access options in Shooting mode. • Delete files in Playback mode. 		

Using the screen

Pull the display outwards and rotate it up or down for high- and low-angle photos.

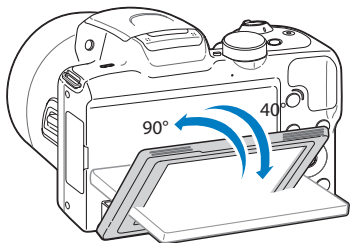
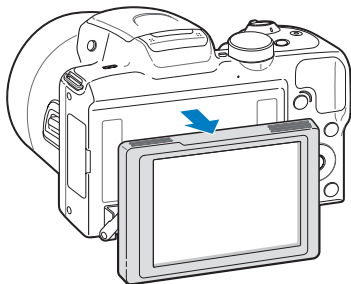

- Fold the display when not in use.
- Rotate the display only within the angle allowed. Or the camera may be damaged.

Low-angle shot

A low-angle shot is a shot from a camera positioned below the eyeline, looking up the subject.

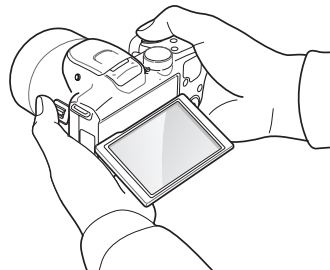

High-angle shot

A high-angle shot is a shot from a camera positioned above the eyeline, looking down on the subject.

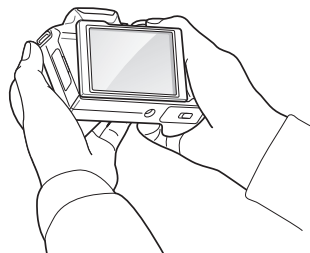

Attaching a strap

Attach a strap to carry your camera conveniently.

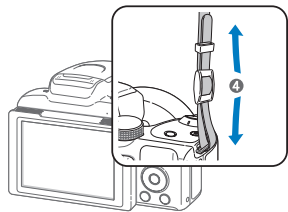
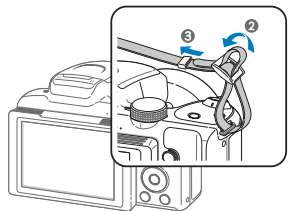
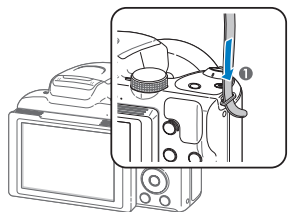

Attaching a lens cap

Attach a lens cap with a lens cap strap to protect the camera lens.

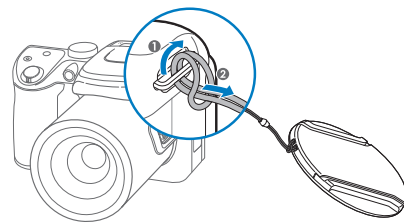
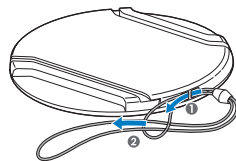

Inserting the battery and memory card

Learn how to insert the battery and an optional memory card into the camera.

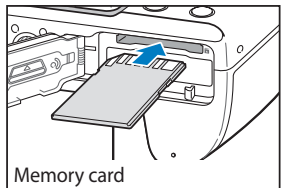
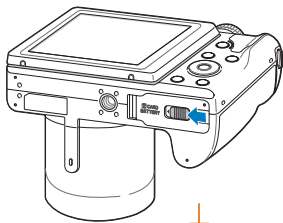

Memory card

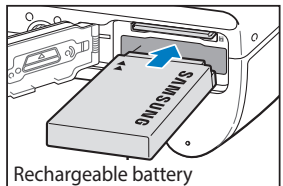

Rechargeable battery

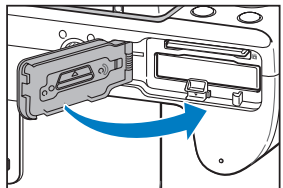

Insert a memory card with the gold-colored contacts facing up.

Insert the battery with the Samsung logo facing up.

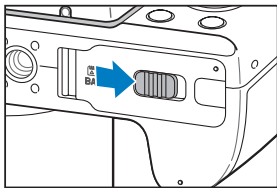

Removing the battery and memory card

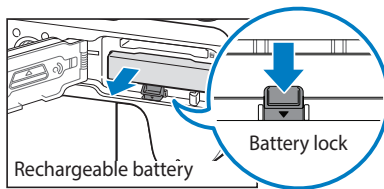

Rechargeable battery

Battery lock

Slide the lock down to release the battery.

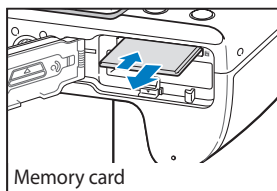

Memory card

Push the card gently until it disengages from the camera, and then pull it out of the slot.

Using the memory card adapter

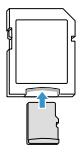

To use micro memory cards with this product, a PC, or a memory card reader, insert the card into an adapter.



You can use the internal memory for temporary storage if a memory card is not inserted.

Charging the battery and turning on your camera

Charging the battery

Before you use the camera for the first time, you must charge the battery. Plug the small end of the USB cable into your camera, and then plug the other end of the USB cable into the AC adapter.

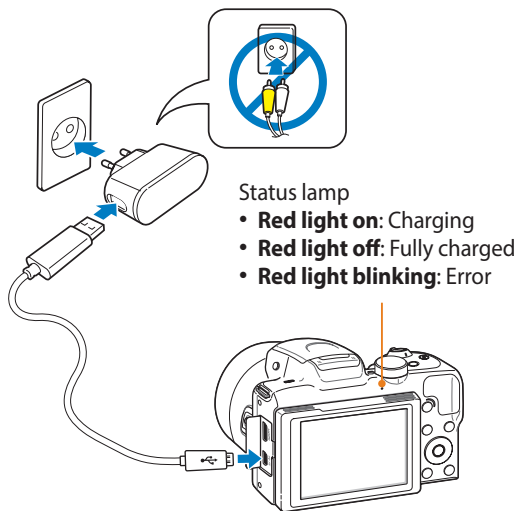

Turning on your camera

Press [ON] to turn your camera on or off.

- The initial setup screen appears when you turn on the camera for the first time. (p. 22)

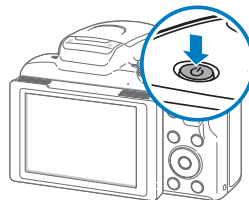

Turning on your camera in Playback mode

Press [▶]. The camera turns on and immediately accesses Playback mode.

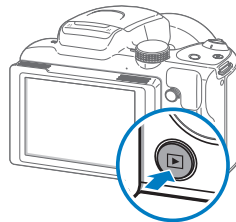

Use only the AC adapter and USB cable supplied with your camera. If you use another AC adapter (such as SAC-48), the camera battery may not charge or work properly.



If you turn on your camera by pressing and holding [▶] until the status lamp blinks, the camera does not emit any sounds.

Performing the initial setup

When the initial setup screen appears, follow the steps below to configure the camera's basic settings. The default language is preset for the country or region where the camera is sold. You can change the language as desired by selecting **Language**.

- 1 Press [] to select **Time Zone**, and then press [] or [**OK**].
- 2 Press [] to select a time zone, and then press [**OK**].

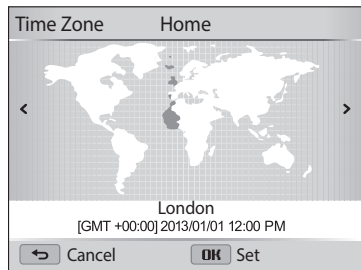

- 3 Press [] to select **Date/Time Set**, and then press [] or [**OK**].

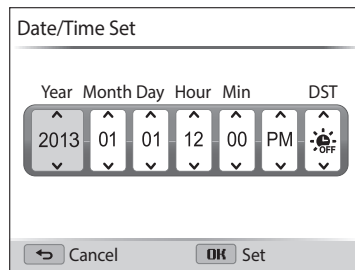

- 4 Press [] to select an item.
- 5 Press [**DISP**/] to set the date, time, and daylight-saving time, and then press [**OK**].

6 Press [

7 Press [DISP/

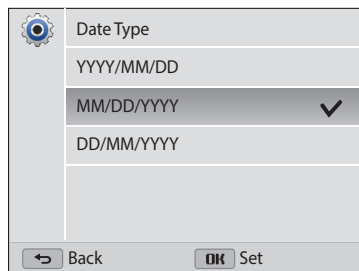

8 Press [Time Type, and then press [

9 Press [DISP/

10 Press [



The screen may differ depending on the language selected.

Learning icons

The camera displays icons for the mode and options you set. The icons flash yellow for a while if you change options.

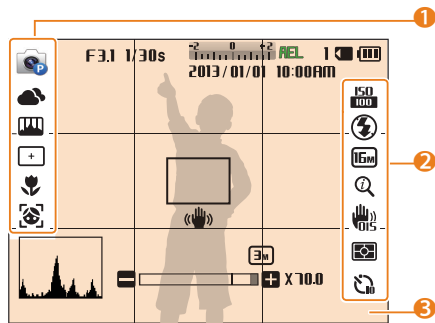

1 Shooting options (left)







Icon	Description
	Shooting mode
	White Balance
	Image adjustment (Sharpness, Contrast, and Saturation)
	Focus Area
	Focus
	Face Detection





2 Shooting options (right)

Icon	Description
	ISO sensitivity
	Video resolution

Icon	Description
	Flash
	Frame Rate (per second)
	Photo resolution
	Zoom Mute
	Intelli zoom on
	Smart Filter
	Optical Image Stabilization (OIS)
	Metering
	Timer
	Continuous mode
	Precapture mode
	Bracket mode

3 Shooting information

Icon	Description
F3.1	Aperture value
1/30s	Shutter speed
00:00:10	Available recording time
	Exposure value
AEL	Auto Exposure Lock on
1	Available number of photos
	Memory card inserted
	<ul style="list-style-type: none"> : Fully charged : Partially charged : Empty (Recharge)

Icon	Description
2013/01/01	Current date
10:00AM	Current time
	Auto focus frame
	Camera shake
	Zoom indicator
	Photo resolution when the Intelli zoom is on
X 70.0	Zoom ratio
	Histogram

Using the Mode screen

Use the mode dial to select a shooting mode or function. Rotate the mode dial to a desired mode.

Selecting a Mode Screen







In Shooting or Playback mode, rotate the mode dial to display a Mode Screen. You can select an icon on the Mode screen in Magic Plus mode.













▲ For example: When you select **Low Light Shot** in Magic Plus mode.

No.	Description
1	Current Mode screen <ul style="list-style-type: none">Rotate the mode dial to go to another mode screen.
2	Mode icons <ul style="list-style-type: none">Press [DISP/📷/🔋/📷] to scroll to a desired mode, and then press [OK] to access the mode.

Icons on the Mode screen

Mode	Icon	Description
		Smart Auto: Capture a photo with a scene mode selected automatically by the camera. (p. 40)
P		Program: Capture a photo with settings you have adjusted manually. (p. 42)
M		Manual: Adjust both the aperture value and the shutter speed manually. (p. 43)
SCN		Scene: Capture a photo with options preset for a specific scene. (p. 44)
		Panorama: Capture and combine a series of photos to create a panoramic image. (p. 45)

Mode	Icon	Description
		Low Light Shot: Capture multiple photos in low light conditions without a flash. The camera combines them to create a single image that is brighter and has less blurring. (p. 47)
		HDR: Capture scenes with emphasis on mid-tones, by minimizing the dark and bright areas. (p. 47)
		Split Shot: Capture several photos and arrange them with preset layouts. (p. 48)
		Photo Filter: Capture a photo with various filter effects. (p. 49)
		Movie Filter: Record a video with various filter effects. (p. 50)
		Photo Editor: Edit photos with various effects. (p. 91)
		Settings: Adjust settings to match your preferences. (p. 105)
		Movie: Customize settings to record a video. (p. 51)

Selecting options or menus

To select an option or a menu, press [MENU] or [Fn].

Using [MENU]

To select an option or a menu, press [MENU], and then press [DISP/⬇️/⚡️/⬆️] or [OK].

- 1 In Shooting mode, press [MENU].
- 2 Select an option or a menu.
 - To move up or down, press [DISP] or [⬇️].
 - To move left or right, press [⚡️] or [⬆️].

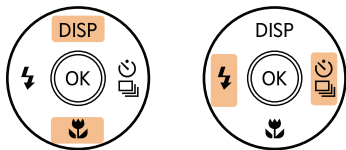

- 3 Press [OK] to confirm the highlighted option or menu.

Going back to the previous menu

Press [↶] to go back to the previous menu.



Half-press [Shutter] to return to Shooting mode.

For example, to select a White Balance option in Program mode:

- 1 Rotate the mode dial to **P**.

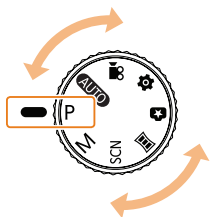

- 2 Press **[MENU]**.

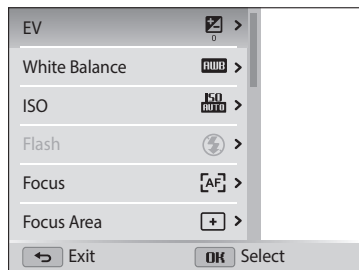

- 3 Press **[DISP/√]** to select **White Balance**, and then press **[]** or **[OK]**.
- 4 Press **[/]** to select a White Balance option.

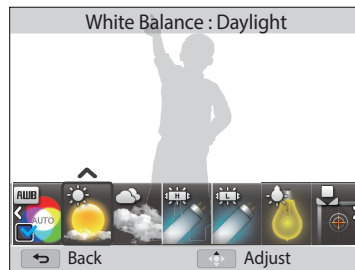

- 5 Press **[OK]** to save your settings.

Using [Fn]

You can also access shooting options by pressing [Fn], but some options are not available.

For example, to select a White Balance option in Program mode:

- 1 Rotate the mode dial to **P**.

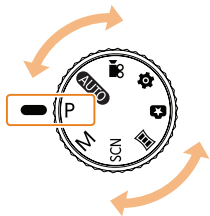

- 2 Press [Fn].
- 3 Press [DISP/🌸/🔋/📶] to select **White Balance**.

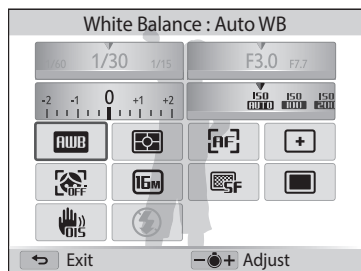

- 4 Rotate [Zoom] to select a White Balance option.

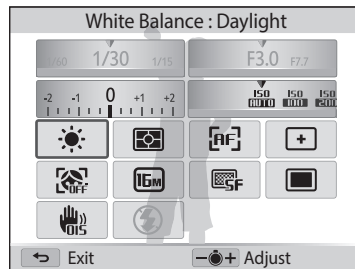

- You can also press [OK] and then press [🔋/📶] to select an option.

- 5 Press [MENU] or [Fn] to save your settings.

Setting the display and sound

Learn how to change the basic display information and sound settings.

Setting the display type

You can select a display type for the Shooting or Playback mode. Each type displays different shooting or playback information. See the table below.

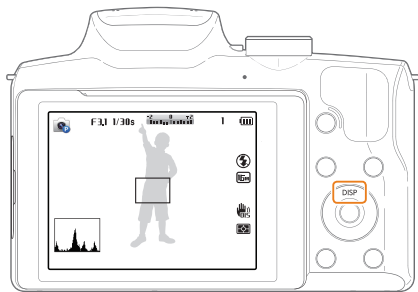

Press **[DISP]** repeatedly to change the display type.

Mode	Display type
Shooting	• Hide all information about shooting options.
	• Show all information about shooting options.
	• Show all information about shooting options and a histogram.
Playback	• Hide all information about the current file.
	• Hide all information about the current file except basic information.
	• Show all information about the current file.

About histograms

A histogram is a graph that illustrates how light is distributed in your photo. If the histogram has a high peak on the left, the photo is underexposed and will appear dark. A peak on the right of the graph means that the photo is overexposed and will appear washed out. The height of the peaks is related to color information. The more of a particular color, the taller the peak.



▲ Under-exposed

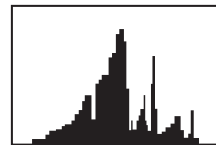

▲ Well-exposed



▲ Over-exposed

Setting the option display view

You can hide or show the option display appearing in some modes.

Press **[OK]** repeatedly.

- Hide the option display.
- Show the option display.

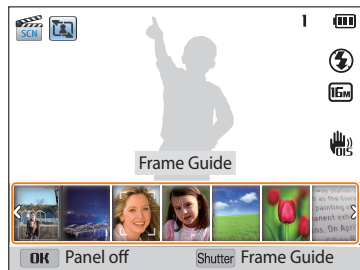

▲ For example, in SCN mode

Setting the sound

Turn on or off the sound your camera emits when you perform functions.

- 1 Rotate the mode dial to .
- 2 Select **Sound** → **Beep Sound**.
- 3 Select an option.

Option	Description
Off	The camera does not emit any sounds.
On	The camera emits sounds.

Capturing photos

Learn how to capture photos easily and quickly in Smart Auto mode.

- 1 Rotate the mode dial to **AUTO**.

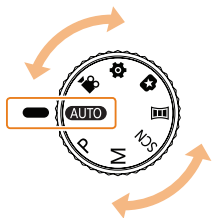

- 2 Align your subject in the frame.

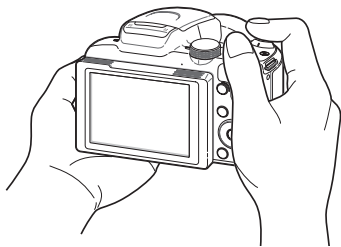

- 3 Half-press [**Shutter**] to focus.
 - A green frame means the subject is in focus.
 - A red frame means the subject is out of focus.

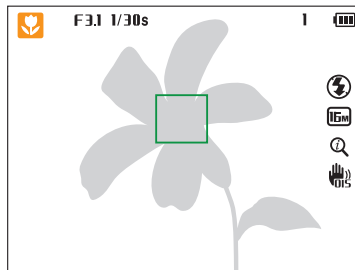

- 4 Press [**Shutter**] to capture a photo.
- 5 Press [**▶**] to view the captured photo.
 - To delete the photo, press [**Fn**], and then select **Yes**.
- 6 Press [**▶**] to return to Shooting mode.



See page 37 for tips to get clearer photos.

Zooming

You can capture close-up photos by adjusting the zoom.

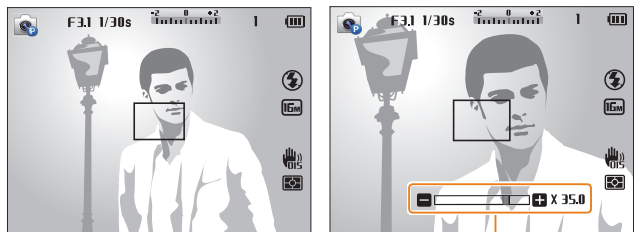

Zoom ratio

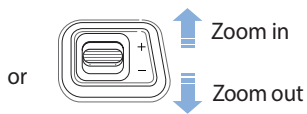

or

Digital zoom P M SCN

The Digital zoom is supported by default in Shooting mode. If you zoom in on a subject in Shooting mode and the zoom indicator is in the digital range, your camera is using the Digital zoom. By using both the 35X Optical zoom and 2X Digital zoom, you can zoom in up to 70 times.

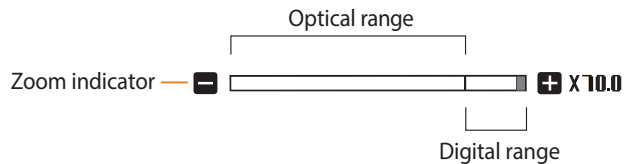

- Digital zoom is not available with the Tracking AF option.
- If you capture a photo with the Digital zoom, the photo quality may be lower than normal.

Intelli zoom

AUTO P M

If the zoom indicator is in the Intelli range, your camera is using the Intelli zoom. Photo resolution varies according to the zoom rate if you use the Intelli zoom. By using both the Optical zoom and Intelli zoom, you can zoom in up to 70 times.

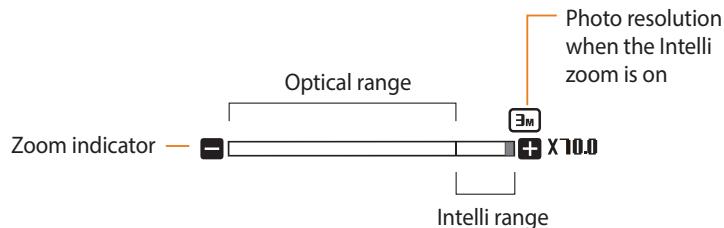

- Intelli zoom is not available with the Tracking AF and Selection AF options.
- The Intelli zoom helps you capture a photo with less quality deterioration than the Digital zoom. However, the photo quality may be lower than when you use the Optical zoom.
- The Intelli zoom is available only when you set a 4:3 resolution ratio. If you set another resolution ratio with Intelli zoom on, the Intelli zoom will be turned off automatically.
- The Intelli zoom is always on in **AUTO** mode.

Setting Intelli zoom

P M

- 1 In Shooting mode, press **[MENU]**.
- 2 Select **Intelli Zoom**.
- 3 Select an option.

Icon	Description
	Off: The Intelli zoom is deactivated.
	On: The Intelli zoom is activated.

Reducing camera shake (OIS) (AUTO P M SCN ★)

In Shooting mode, you can set either the Optical Image Stabilizer (OIS) to reduce or eliminate picture blurriness from camera shake.



▲ Before correction



▲ After correction

- 1 In Shooting mode, press **[MENU]**.
- 2 Select **OIS**.
- 3 Select an option.

Icon	Description
	Off: OIS is deactivated.
	On: OIS is activated.



- OIS may not function properly when:
 - you move your camera to follow a moving subject
 - you use the Digital zoom
 - there is too much camera shake
 - the shutter speed is slow (for example, when you capture night scenes)
 - the battery is low
 - you capture a close-up shot
- If you use the OIS function with a tripod, your images may be blurred by the vibration of the OIS sensor. Deactivate the OIS function when you use a tripod.
- If the camera is hit or dropped, the display will be blurry. If this occurs, turn off the camera, and then turn it on again.

Tips for getting a clearer photo



Holding your camera correctly

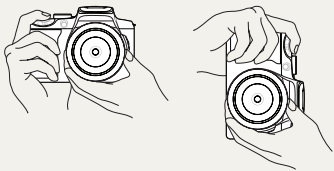

Ensure nothing is blocking the lens, flash, or microphone.



Half-pressing the shutter button

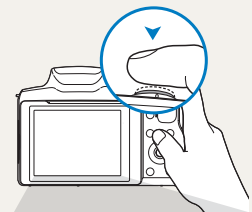

Half-press [**Shutter**] and adjust the focus. The camera adjusts the focus and exposure automatically.

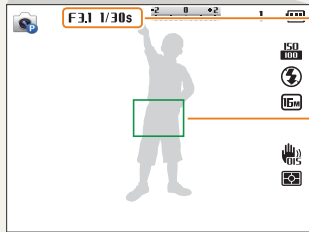

The camera sets the aperture value and shutter speed automatically.

Focus frame

- Press [**Shutter**] to capture the photo if the focus frame appears in green.
- Change the composition and half-press [**Shutter**] again if the focus frame appears in red.



Reducing camera shake



Set the Optical Image Stabilization option to reduce camera shake digitally. (p. 36)



When (ⓘ) is displayed

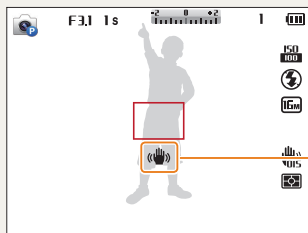

Camera shake

When you shoot in the dark, avoid setting the flash option to **Slow Sync** or **Off**. The aperture remains open longer and it may be harder to hold the camera steady long enough to capture a clear photo.

- Use a tripod or set the flash option to **Fill in**. (p. 60)
- Set ISO sensitivity options. (p. 62)



Preventing your subject from being out of focus

It may be difficult to get your subject in focus when:

- there is little contrast between the subject and background (for example, when your subject is wearing clothing that is similar in color to the background)
- the light source behind the subject is too bright
- the subject is shiny or reflective
- the subject includes horizontal patterns, such as blinds
- the subject is not positioned in the center of the frame



Using the focus lock

Half-press **[Shutter]** to focus. When the subject is in focus, you can reposition the frame to change the composition. When you are ready, press **[Shutter]** to capture your photo.

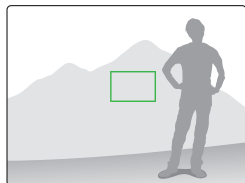
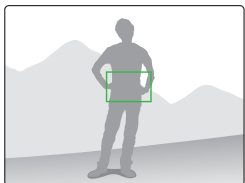

- When you capture photos in low light



Turn on the flash.
(p. 60)

- When subjects are moving rapidly

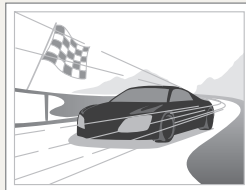

Use the Continuous
or Precapture
function. (p. 75)

Extended functions

Learn how to capture a photo and record a video by selecting a mode.

Using the Smart Auto mode	40	Using the Movie mode	51
Using the Program mode	42	Recording high-speed videos	53
Using the Manual mode	43	Using the Smart Scene Detection mode	54
Using the Scene mode	44		
Using the Panorama mode	45		
Using the Magic Plus mode	47		
Using the Low Light Shot mode	47		
Using the HDR mode	47		
Using the Split Shot mode	48		
Using the Photo Filter mode	49		
Using the Movie Filter mode	50		







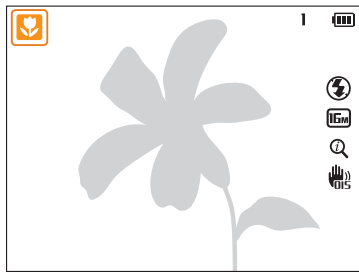





Using the Smart Auto mode



In Smart Auto mode, your camera automatically chooses the appropriate camera settings based on the type of scene it detects. The Smart Auto mode is helpful if you are not familiar with the camera settings for various scenes.

- 1 Rotate the mode dial to **AUTO**.
- 2 Align your subject in the frame.
 - The camera automatically selects a scene. An appropriate scene icon appears at the top left of the screen. The icons are listed below.



- 3 Half-press [**Shutter**] to focus.
- 4 Press [**Shutter**] to capture the photo.

Icon	Description
	Landscapes
	Scenes with bright white backgrounds
	Landscapes at night
	Portraits at night
	Landscapes with backlighting
	Portraits with backlighting
	Portraits
	Close-up photos of objects
	Close-up photos of text
	Sunsets
	Blue skies
	Forested areas
	Close-up photos of colorful subjects

Icon	Description
	Camera is stabilized on a tripod and the subject is not moving for a certain period of time. (when shooting in the dark)
	Actively moving subjects



- If the camera does not recognize an appropriate scene mode, it uses the default settings for **AUTO** mode.
- Even if it detects a face, the camera may not select a portrait mode depending on the subject's position or lighting.
- The camera may not select the correct scene depending on the shooting conditions, such as camera shake, lighting, or distance to the subject.
- Even if you use a tripod, the camera may not detect the  mode if the subject is moving.
- The camera consumes more battery power, because it changes settings often to select appropriate scenes.



Using the Program mode

In Program mode, you can set most options, except the shutter speed and aperture value, which the camera sets automatically.

- 1 Rotate the mode dial to **P**.
- 2 Set the desired options.
 - For a list of options, refer to "Shooting options". (p. 55)
- 3 Align your subject in the frame, and then half-press [**Shutter**] to focus.
- 4 Press [**Shutter**] to capture the photo.

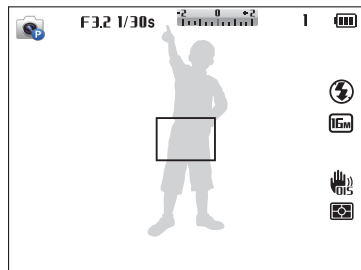

Using the Manual mode

The Manual mode allows you to adjust both the aperture value and the shutter speed manually.

- 1 Rotate the mode dial to **M**.
- 2 Press [**OK**], and then press [**⚡/📷**] to select the aperture or shutter speed.
- 3 Press [**DISP/🌸**] to adjust the aperture value or shutter speed.
- 4 Set the desired options.
 - For a list of options, refer to "Shooting options". (p. 55)
- 5 Align your subject in the frame, and then half-press [**Shutter**] to focus.
- 6 Press [**Shutter**] to capture the photo.

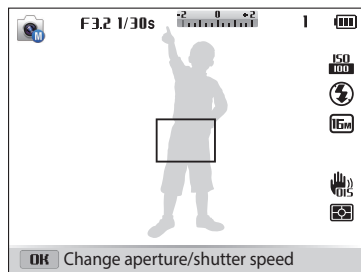

Using the Scene mode

In Scene mode, you can capture a photo with options that are preset for a specific scene.

- 1 Rotate the mode dial to **SCN**.
- 2 Select a scene.

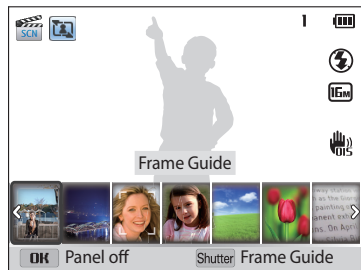

- 3 Align your subject in the frame, and then half-press [**Shutter**] to focus.
- 4 Press [**Shutter**] to capture the photo.

Option	Description
Frame Guide	Help the other person capture a photo of you by showing part of the pre-composed scene.
Night	Capture scenes at night or in low lighting (using a tripod is recommended).
Portrait	Automatically detect and focus on human faces so that you can achieve clear, soft portraits.
Children	Make children appear more noticeable by capturing.
Landscape	Capture still-life scenes and landscapes.
Close up	Capture detailed parts of a subject or small subjects, such as flowers or insects.
Text	Clearly capture text from printed or electronic documents.
Sunset	Capture scenes at sunset, with natural-looking reds and yellows.
Dawn	Capture scenes at sunrise.
Backlight	Capture backlit subjects.
Fireworks	Capture colorful fireworks at night.
Beach & Snow	Reduce underexposure of subjects caused by sunlight reflected from sand or snow.

Using the Panorama mode

In Panorama mode, you can capture a wide panoramic scene in a single photo. Capture and combine a series of photos to create a panoramic image.



▲ Shooting example

- 1 Rotate the mode dial to .
- 2 Align your subject in the frame, and then half-press **[Shutter]** to focus.
 - Align the camera with the far left or the far right, or very top or bottom, of the scene you want to capture.
- 3 Press and hold **[Shutter]** to start shooting.

- 4 With **[Shutter]** pressed, slowly move the camera in the direction that will let it capture the rest of the panorama.
 - Arrows toward the direction of motion are displayed, and the entire shooting image is displayed in the preview box.
 - When the viewfinder is aligned with the next scene, the camera captures the next photo automatically.

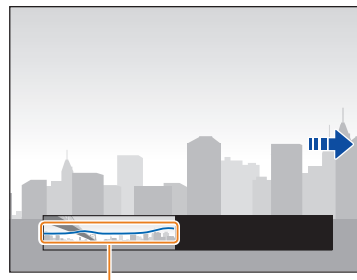

- 5 When you are finished, release **[Shutter]**.
 - When you have captured all the necessary shots, the camera combines them into one panoramic photo.





- For best results when capturing panoramic photos, avoid the following:
 - moving the camera too quickly or too slowly
 - moving the camera too little to capture the next image
 - moving the camera at irregular speeds
 - shaking the camera
 - shooting in dark places
 - capturing moving subjects nearby
 - shooting conditions where the brightness or color of light is changing
- Photos taken are automatically saved, and shooting is stopped under the following conditions:
 - if you change the shooting direction while shooting
 - if you move the camera too rapidly
 - if you don't move the camera
- Selecting Panorama mode will disable the digital and optical zoom functions. If you select Panorama mode while the lens is zoomed in, the camera automatically zooms out to the default position.
- Some shooting options are not available.
- The camera may stop shooting due to the shooting composition or movement within the scene.
- Your camera may not capture the last scene in its entirety if you stop moving the camera exactly where you want the scene to end. To capture the entire scene, move your camera slightly beyond the point where you want the scene to end.

Using the Magic Plus mode

Capture a photo or record a video by selecting appropriate modes for various effects.

Using the Low Light Shot mode

In low light conditions, capture multiple photos and combine them into a bright image having less blurring and noise without using the flash.

- 1 Rotate the mode dial to .
- 2 Select .
- 3 Align your subject in the frame, and then half-press [**Shutter**] to focus.
- 4 Press [**Shutter**] to capture the photo.

Using the HDR mode



In HDR(High Dynamic Range) mode, your camera captures three photos with different exposures, and then overlays the bright area of the underexposed photo and the dark area of the overexposed photo. You can capture photos with soft, rich colors.



▲ Without HDR effect



▲ With HDR effect



- 1 Rotate the mode dial to .
- 2 Select .
- 3 Align your subject in the frame, and then half-press [**Shutter**] to focus.
- 4 Press [**Shutter**] to capture the photo.
 - The camera captures 3 photos, and then automatically merges them into a single photo.



- The HDR effect may be affected by camera shake, lighting, movement of the subject, and the shooting environment.
- You cannot use the flash when you use the HDR mode.
- It may take longer to save a photo using the HDR mode.
- When you use the HDR mode, the preview image on the screen and the captured photo may appear slightly larger than a photo captured without this effect.
- When you capture a moving subject using the HDR mode, an afterimage may appear.

Using the Split Shot mode

In Split Shot mode, you can capture several photos and arrange them with preset layouts.

- 1 Rotate the mode dial to .
- 2 Select .
- 3 Select a split style.
 - To adjust the sharpness of the dividing line, press [MENU], and then select **Line Blur** → a desired value.
 - To apply a Smart Filter effect to part of the shot, press [MENU], and then select **Smart Filter** → a desired option. You can apply different Smart Filter effects to each part of the shot.

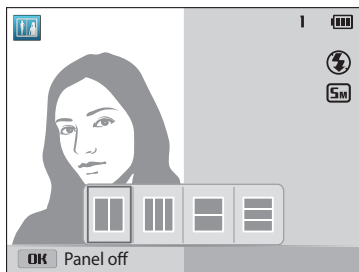

- 4 Align your subject in the frame, and then half-press [Shutter] to focus.
- 5 Press [Shutter] to capture a photo.
 - Repeat steps 4 and 5 to capture the rest of the photos.
 - To recapture a photo, press [↶].
- 6 Press [OK] to save the photo.



The resolution is automatically set to  or smaller.

Using the Photo Filter mode

Apply various filter effects to your photos to create unique images.



Miniature





Vignetting



Fish-eye



Classic

- 1 Rotate the mode dial to .
- 2 Select .
- 3 Select an effect.

Option	Description
Miniature	Apply a tilt-shift effect to make the subject appear in miniature. (The top and bottom of the photo will be blurred.)
Vignetting	Apply the retro-looking colors, high contrast, and strong vignette effect of Lomo cameras.
Cross Filter	Add lines that radiate outward from bright objects to imitate the visual effect of a cross filter.
Fish-eye	Distort close objects to imitate the visual effect of a fisheye lens.
Classic	Apply a black and white effect.
Retro	Apply a sepia tone effect.



- 4 Align your subject in the frame, and then half-press [**Shutter**] to focus.
- 5 Press [**Shutter**] to capture a photo.





- Depending on the option you select, the resolution may change to **5m** or smaller automatically.
- To apply filter effects to saved photos, press [**MENU**], and then select **Open Image** → a desired image.

Using the Movie Filter mode

Apply various filter effects to your videos to create unique images.

- 1 Rotate the mode dial to .
- 2 Select .
- 3 Select an effect.

Option	Description
Miniature	Apply a tilt-shift effect to make the subject appear in miniature. (The top and bottom of the photo will be blurred.)
Vignetting	Apply the retro-looking colors, high contrast, and strong vignette effect of Lomo cameras.
Fish-eye	Distort close objects to imitate the visual effect of a fisheye lens.
Classic	Apply a black and white effect.
Retro	Apply a sepia tone effect.
Palette Effect 1	Create a vivid look with sharp contrast and strong color.
Palette Effect 2	Make scenes clean and clear.
Palette Effect 3	Apply a soft brown tone.
Palette Effect 4	Create a cold and monotone effect.

- 4 Press  (Video recording) to start recording.
- 5 Press  (Video recording) again to stop recording.







- If you select **Miniature**, playback speed will increase.
- If you select **Miniature**, you cannot record the video sound.
- Depending on the option you select, the recording resolution may change to **VGA** or smaller automatically.

Using the Movie mode



In Movie mode, you can customize settings to record Full HD (1920 X 1080) videos of up to 20 minutes in length. The camera saves recorded videos as MP4 (H.264) files.



- MP4 (H.264) is a high-compression video format established by the international standards organizations ISO-IEC and ITU-T.
- If you use memory cards with slow write speeds, the camera may not save videos properly. Video recordings may be corrupted or fail to play back correctly.
- Memory cards with slow writing speeds will not support high-resolution videos. To record high-resolution videos, use memory cards with faster write speeds.
- If you use the zoom function when recording a video, the camera may record the noise of the zoom operating. Use the Zoom Mute function not to record zoom noise. (p. 79)

- 1 Rotate the mode dial to .
- 2 Set desired options.
 - For a list of options, refer to "Shooting options". (p. 55)
- 3 Press  (Video recording) to start recording.
 - Press [
- 4 Press  (Video recording) again to stop recording.



- You can start recording a video in some modes by pressing  (Video recording) without having to rotate the mode dial to .
- The video frame size may appear smaller while you are recording a video depending on the video resolution and frame rate.

Pause recording

The camera allows you to temporarily pause a video while recording. With this function, you can record separate scenes as a single video.

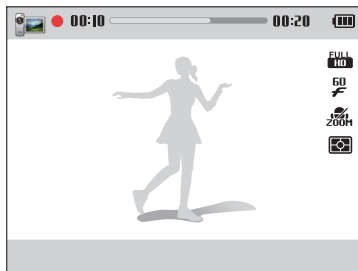

- Press **[OK]** to pause while recording.
- Press **[OK]** to resume.

Capturing still images while recording a video

You can capture still images while recording a video without switching to the photo shooting modes (up to 6 photos).

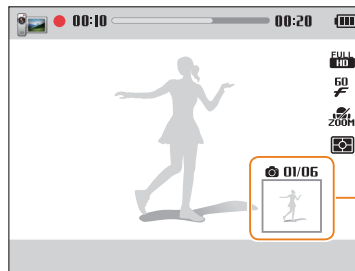

Images captured while recording a video

- Press **[Shutter]** to capture images while recording a video.
 - Captured images will be saved automatically.
- Captured images will be automatically resized, depending on the size of the recorded video.
 - You cannot capture still images while recording high-speed videos.
 - You cannot capture still images when you pause the video recording.
 - The quality of images captured while recording a video may be lower than those captured normally.

Recording high-speed videos

You can record high-speed videos by setting frame rates. High-speed videos will be played in slow motion at 60 FPS or 30 FPS, depending on the frame rate of the video.





- Memory cards with slow write speeds do not support high-speed videos.
- The camera does not record audio when recording high-speed videos.
- The image quality of high-speed video may be lower than normal speed video.

1 Rotate the mode dial to .

- You can record a high-speed video only in  mode.

2 Press [MENU] and then select **Frame Rate**.

3 Select an option.

Icon	Description
	360 fps: Record 360 frames per second (for up to 10 seconds).
	240 fps: Record 240 frames per second (for up to 10 seconds).

4 Press  (Video recording) to start recording.





5 Press  (Video recording) again to stop recording.



Using the Smart Scene Detection mode

In Smart Scene Detection mode, your camera automatically chooses the appropriate camera settings based on the scene it has detected.

- 1 Rotate the mode dial to .
- 2 Press [MENU].
- 3 Select **Smart Scene Detection** → **On**.
- 4 Align your subject in the frame.
 - The camera automatically selects a scene. An appropriate scene icon will appear at the top left of the screen.



Icon	Description
	Landscapes
	Sunsets
	Blue skies
	Forested areas

- 5 Press  (Video recording) to start recording.
- 6 Press  (Video recording) again to stop recording.



- If the camera does not recognize an appropriate scene mode, it uses the default settings for the Smart Scene Detection mode.
- The camera may not select the correct scene depending on the shooting conditions, such as camera shake, lighting, and distance to the subject.

Shooting options

Learn how to set the options in Shooting mode.

Selecting a resolution and quality	56	Detecting eye blinking	68
Selecting a resolution	56	Tips for detecting faces	69
Selecting an image quality	57	Adjusting brightness and color	70
Using the timer	58	Adjusting the exposure manually (EV)	70
Shooting in the dark	59	Locking the exposure value (AEL)	71
Preventing red-eye	59	Compensating for backlighting (ACB)	71
How to use the flash	59	Changing the metering option	72
Using the flash	60	Selecting a White Balance setting	72
Adjusting the ISO sensitivity	62	Using burst modes	
Changing the camera's focus	63	(Continuous/Precapture/Bracket)	75
Using macro	63	Capturing continuous photos	75
Changing the focus option	63	Capturing photos in the Precapture mode	76
Adjusting the focus area	64	Capturing bracketed photos	76
Using Face Detection	67	Adjusting images	78
Detecting faces	67	Reducing the sound of the zoom	79
Capturing a self portrait shot	67		
Capturing a smile shot	68		

Selecting a resolution and quality









Learn how to change the image resolution and quality settings.

Selecting a resolution

As you increase the resolution, your photo or video will include more pixels, so it can be printed on larger paper or displayed on a larger screen. When you use a high resolution, the file size will also increase.

Setting the photo resolution (AUTO) P M SCN ☆





- 1 In Shooting mode, press [MENU].
- 2 Select **Photo Size**.
- 3 Select an option.

Icon	Description
	4608 X 3456: Print on A1 paper.
	4608 X 3072: Print on A1 paper in wide ratio (3:2).
	4608 X 2592: Print on A1 paper in panorama ratio (16:9) or play back on an HDTV.
	3648 X 2736: Print on A2 paper.
	2832 X 2832: Print on A3 paper in 1:1 ratio.
	2592 X 1944: Print on A4 paper.
	1984 X 1488: Print on A5 paper.
	1920 X 1080: Print on A5 paper in panorama ratio (16:9) or play back on an HDTV.
	1024 X 768: Attach to an email.

Setting the video resolution

(AUTO) P M SCN ☆

- 1 In Shooting mode, press [MENU].
- 2 Select **Movie Size**.
- 3 Select an option.

Icon	Description
	1920 X 1080: High-quality HD files to play back on an HDTV.
	1280 X 720: HD files to play back on an HDTV.
	640 X 480: SD files to play back on an analog TV.
	320 X 240: Post on a web page.



Selecting an image quality

Set the photo and video quality settings. Higher image quality settings will result in larger file sizes.

Setting the photo quality P M SCN

The camera compresses and saves the photos you capture in the JPEG format.





- 1 In Shooting mode, press [MENU].
- 2 Select **Quality**.
- 3 Select an option.

Icon	Description
	Super Fine: Capture photos in super high quality.
	Fine: Capture photos in high quality.
	Normal: Capture photos in normal quality.

Setting the video frame rate

The camera compresses and saves the videos you record in MP4 (H.264) format.

- 1 In Video Shooting mode, press [MENU].
- 2 Select **Frame Rate**.
- 3 Select an option.

Icon	Description
	360 fps: Record 360 frames per second.
	240 fps: Record 240 frames per second.
	60 fps: Record 60 frames per second.
	30 fps: Record 30 frames per second.

Available options may differ depending on the video resolution.

Using the timer

AUTO P M SCN ★ 📷

Learn how to set the timer to delay shooting.

1 In Shooting mode, press [📷].

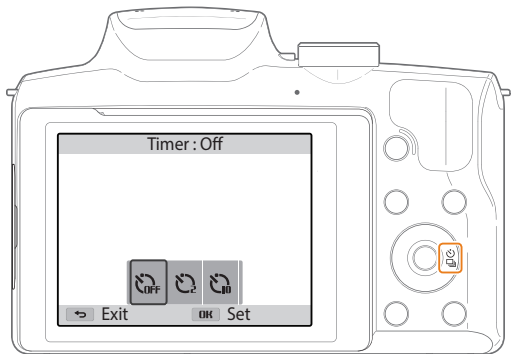

2 Select an option.

Icon	Description
	Off: The timer is not active.
	2 Sec: Capture a photo after a 2-second delay.
	10 Sec: Capture a photo after a 10-second delay.

Available options may differ depending on the shooting conditions.

3 Press [**Shutter**] to start the timer.

- The AF-assist light/timer lamp blinks. The camera will automatically capture a photo after the specified time has elapsed.



- Press [**Shutter**] or [📷] to cancel the timer.
- Depending on the Face Detection options you selected, the timer function may not be available.
- Timer options are not available if you set burst options.
- In some modes, you can also set the timer option by pressing [MENU], and then selecting **Timer** or **Drive/Timer**.

Shooting in the dark

Learn how to capture photos at night or in low light conditions.

Preventing red-eye P SCN

If the flash fires when you capture a photo of a person in the dark, a red glow may appear in the person's eyes. To prevent this, select **Red-eye** or **Red-eye Fix**. Refer to flash options in "Using the flash."



▲ Before correction



▲ After correction

How to use the flash

Press [] to pop the flash up when it is needed.

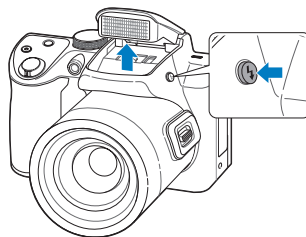

When the flash unit is closed, the flash does not fire regardless of the selected option. When the flash unit pops up, the flash fires according to the selected option.



- While not in use, keep the flash unit closed to prevent damage.
- Forcing open the flash unit may cause damage to your camera.

Press down gently to close.

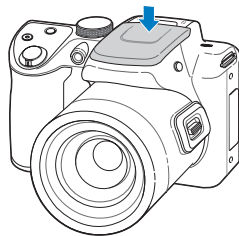

Using the flash (AUTO) P M SCN

Use the flash when you capture photos in the dark or when you need more light in your photos.



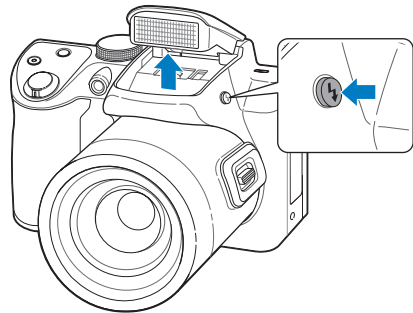

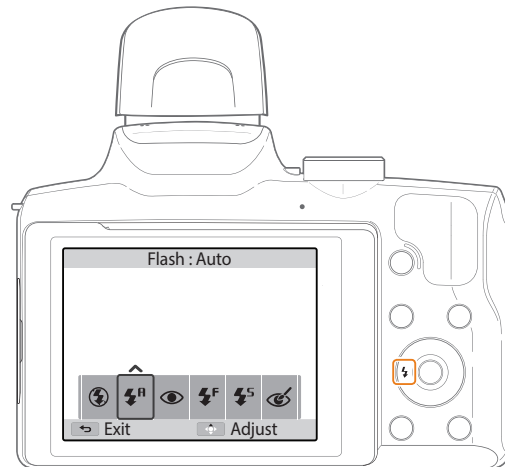

- 1 Press [] to pop the flash up when it is need.



- 2 In Shooting mode, press [].



3 Select an option.

Icon	Description
	<p>Off:</p> <ul style="list-style-type: none"> The flash will not fire. The camera will display the shake warning  when you are shooting in low light.
	<p>Auto: The flash will fire automatically when the subject or background is dark.</p>
	<p>Red-eye:</p> <ul style="list-style-type: none"> The flash will fire twice when the subject or background is dark to reduce the red-eye effect. There is an interval between the 2 bursts of the flash. Do not move until the flash fires a second time.
	<p>Fill in:</p> <ul style="list-style-type: none"> The flash always fires. The camera automatically adjusts light intensity.
	<p>Slow Sync:</p> <ul style="list-style-type: none"> The flash fires and the shutter stays open longer. This option is recommended when you want to capture more ambient light to reveal more details in the background. Use a tripod to prevent your photos from blurring. The camera will display the shake warning  when you are shooting in low light.

Icon	Description
	<p>Red-eye Fix:</p> <ul style="list-style-type: none"> The flash fires twice when the subject or background is dark. The camera corrects red-eyes through its advanced software analysis. There is an interval between the 2 bursts of the flash. Do not move until the flash fires a second time.

Available options may differ depending on the shooting conditions.

-  Flash options are not available if you set burst options or select **Blink Detection**.
- Make sure that your subjects are within the recommended distance from the flash. (p. 126)
- If light from the flash is reflected or there is a substantial amount of dust in the air, tiny spots may appear in your photo.
- In some modes, you can also set the flash option by pressing [MENU], and then selecting **Flash**.

Adjusting the ISO sensitivity P M

The ISO sensitivity is the measure of a film's sensitivity to light as defined by the International Organization for Standardization (ISO). The higher ISO sensitivity you select, the more sensitive to light your camera becomes. Use a higher ISO sensitivity to capture better photos and reduce camera shake when not using the flash.

- 1 In Shooting mode, press [MENU].
- 2 Select **ISO**.
- 3 Select an option.
 - Select  to use an appropriate ISO sensitivity based on the brightness of the subject and lighting.



Higher ISO sensitivities may result in more image noise.

Changing the camera's focus

Learn how to adjust the camera's focus to suit the subject and the shooting conditions.

Using macro P M SCN

Use macro to capture close-up photos of subjects, such as flowers or insects. (Refer to "Changing the focus option".)



- Try to hold the camera firmly to prevent blurry photos.
- Turn off the flash if the distance to the subject is less than 40 cm.

Changing the focus option P M SCN

You can get clearer photos by selecting an appropriate focus option according to the distance between the camera and subjects.

- 1 In Shooting mode, press [].

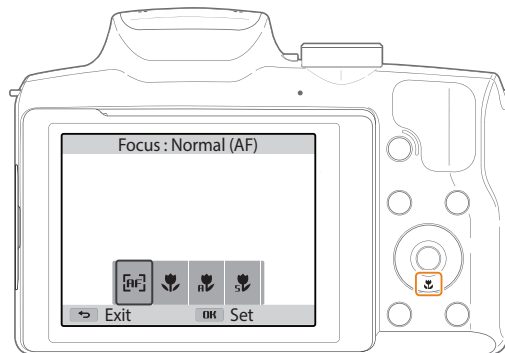

2 Select an option.

Icon	Description
	Normal (AF): Focus on a subject farther than 31 in. (80 cm) away. Farther than 59 in. (150 cm) away when you use the zoom.
	Macro: Focus on a subject that is 4-31 in. (10-80 cm) from the camera. 59-138 in. (150-350 cm) when you use the zoom.
	Auto Macro: <ul style="list-style-type: none"> Focus on a subject farther than 0.4 in. (1 cm) away. Farther than 59 in. (150 cm) away when you use the zoom. It is set automatically in some shooting modes.
	Super Macro: Focus on a subject that is 0.4 in. (1 cm) from the camera.

Available options may differ depending on the shooting conditions.



In some modes, you can also set the focus option by pressing [MENU], and then selecting **Focus**.

Adjusting the focus area P M

You can get clearer photos by selecting an appropriate focus area according to your subject's location in the scene.

- 1 In Shooting mode, press [MENU].
- 2 Select **Focus Area**.
- 3 Select an option.

Icon	Description
	Center AF: Focus on the center of the frame (suitable when subjects are located at or near the center).
	Multi AF: Focus on one or more of 9 possible areas.
	Selection AF: Focus on the area that you select. (p. 65)
	Tracking AF: Focus on and track the subject. (p. 65)

Available shooting options may differ depending on the shooting conditions.

Focusing on a selected area

You can focus on an area that you have selected.

- 1 In Shooting mode, press [MENU].
- 2 Select **Focus Area** → **Selection AF**.
- 3 Press [OK], and then press [DISP/☘/⚡/📷] to move the frame to a desired area.

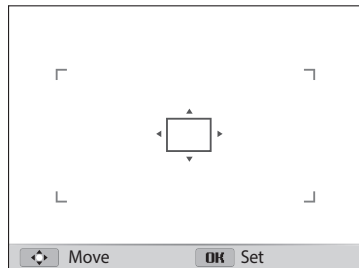

- 4 Press [OK].
- 5 Press [Shutter] to capture the photo.
 - Press [OK] to change the focus area.



If you use this function, you cannot set Face Detection options, Timer options, Burst options, and Intelli zoom.

Using tracking auto focus

Tracking AF allows you to track and auto focus on your subject, even when you are moving.

- 1 In Shooting mode, press [MENU].
- 2 Select **Focus Area** → **Tracking AF**.
- 3 Focus on the subject you want to track, and then press [OK].
 - A focus frame appears on the subject and follows the subject as you move the camera.

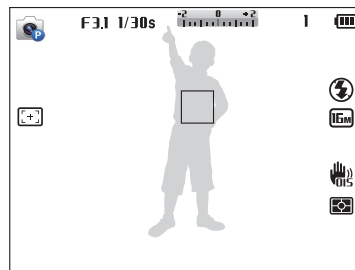

- The white frame means that your camera is tracking the subject.
- When you half-press [Shutter], the green frame means that your subject is in focus.
- The red frame means that your camera failed to focus.

- 4 Press [Shutter] to capture the photo.



- If you do not select a focus area, the focus frame will appear in the center of the screen.
- Tracking a subject may fail when:
 - the subject is too small
 - the subject moves excessively
 - the subject is backlit or you are shooting in a dark place
 - colors or patterns on the subject and the background are the same
 - the subject includes horizontal patterns, such as blinds
 - the camera shakes excessively
- When tracking fails, the feature will be reset.
- If the camera fails to track the subject, you must reselect the subject to track.
- If the camera fails to focus, the focus frame will change to red and the focus will be reset.
- If you use this function, you cannot set Face Detection options, Timer options, Burst options, and Intelli zoom.

Using Face Detection

P M SCN

If you use Face Detection options, your camera can automatically detect a human face. When you focus on a human face, the camera adjusts the exposure automatically. Use **Blink Detection** to detect closed eyes or **Smile Shot** to capture a smiling face.

Detecting faces

Your camera automatically detects up to 10 human faces in one scene.

- 1 In Shooting mode, press **[MENU]**.
- 2 Select **Face Detection** → **Normal**.

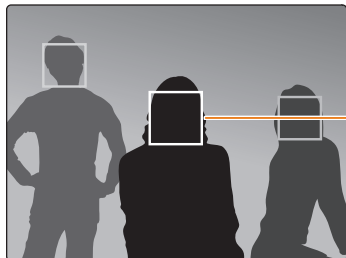

The face nearest the camera or nearest the center of the scene appears in a white focus frame and the rest of the faces appear in gray focus frames.



The closer you are to the subjects, the quicker your camera will detect faces.

Capturing a self portrait shot

Capture photos of yourself. The camera sets the focus distance to close-up, and then emits a beep when ready.

- 1 In Shooting mode, press **[MENU]**.
- 2 Select **Face Detection** → **Self-Portrait**.
- 3 Compose your shot with the lens facing you.
- 4 When you hear a quick beep, press **[Shutter]**.



When faces are located in the center, the camera beeps rapidly.



If you turn Volume off in the sound settings, the camera will not emit a beep. (p. 106)

Capturing a smile shot

The camera automatically releases the shutter when it detects a smiling face.

- 1 In Shooting mode, press [MENU].
- 2 Select **Face Detection** → **Smile Shot**.
- 3 Compose your shot.
 - The camera automatically releases the shutter when it detects a smiling face.



When your subject smiles broadly, your camera can detect the smile more easily.

Detecting eye blinking

If your camera detects closed eyes, it will automatically capture 2 photos in succession.

- 1 In Shooting mode, press [MENU].
- 2 Select **Face Detection** → **Blink Detection**.

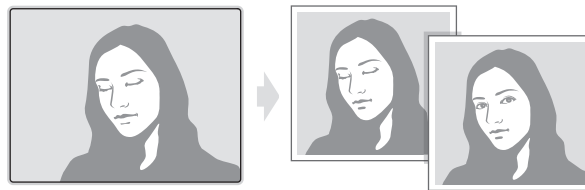

Tips for detecting faces

- When your camera detects a face, it tracks the detected face automatically.
- Face Detection may not be effective when:
 - the subject is far from the camera
 - it is too bright or too dark
 - the subject is not facing the camera
 - the subject is wearing sunglasses or a mask
 - the subject's facial expression changes drastically
 - the subject is backlit or the lighting conditions are unstable
- When you set Face Detection options, the AF area is automatically set to Multi AF.
- Depending on the Face Detection options you selected, some shooting options may not be available.
- Depending on the shooting options you selected, Face Detection options may not be available.

Adjusting brightness and color

Learn how to adjust the brightness and color for better image quality.

Adjusting the exposure manually (EV) P

Depending on the intensity of the ambient light, your photos may be too bright or dark. In these cases, you can adjust the exposure to get a better photo.



▲ Darker (-)



▲ Neutral (0)



▲ Brighter (+)

1 In Shooting mode, press [MENU].

2 Select **EV**.

- 3 Press [] to adjust the exposure.
- The photo will be brighter as the exposure value increases.

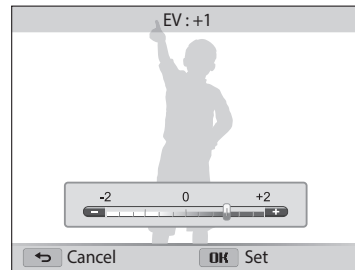

4 Press [OK] to save your settings.



- Once you adjust the exposure, the setting will be stored automatically. You may need to change the exposure value later to avoid overexposure or underexposure.
- If you cannot decide on an appropriate exposure, select **AE Bracket**, and then capture bracketed photos. The camera will capture 3 consecutive photos, each with a different exposure: normal, underexposed, and overexposed. (p. 76)

Locking the exposure value (AEL) P

The adjusted exposure value locks when [AEL] is pressed, and remains locked until [AEL] is pressed again.

- 1 Adjust the exposure manually. (p. 70)
- 2 Press [AEL].
 - The AEL (**REL**) icon turns on.

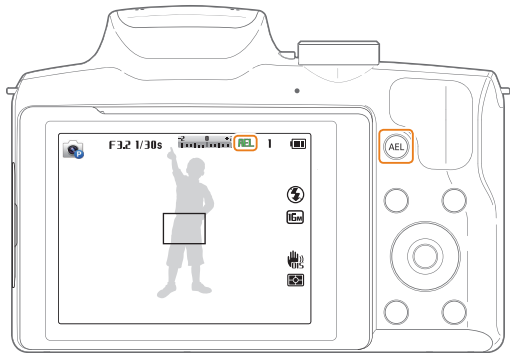

Compensating for backlighting (ACB) P M



When the light source is behind your subject or there is high contrast between your subject and the background, your subject is likely to appear dark in the photo. In this case, set the Auto Contrast Balance (ACB) option.



▲ Without ACB

▲ With ACB

- 1 In Shooting mode, press [MENU].
- 2 Select **ACB**.
- 3 Select an option.

Icon	Description
	Off: ACB (Auto Contrast Balance) is deactivated.
	On: ACB (Auto Contrast Balance) is activated.





- The ACB feature is always on in **AUTO** mode.
- The ACB feature is not available when you set burst options.

Changing the metering option P M

The metering mode refers to the way in which a camera measures the quantity of light. The brightness and lighting of your photos will vary depending on the metering mode you select.

- 1 In Shooting mode, press [MENU].
- 2 Select **Metering**.
- 3 Select an option.

Icon	Description
	<p>Multi:</p> <ul style="list-style-type: none"> • Your camera divides the frame into several areas, and then measures the light intensity of each area. • Suitable for general photos.
	<p>Spot:</p> <ul style="list-style-type: none"> • Your camera measures only the light intensity at the very center of the frame. • If a subject is not in the center of the frame, your photo may be improperly exposed. • Suitable for a subject with backlighting.
	<p>Center-weighted:</p> <ul style="list-style-type: none"> • Your camera averages the meter reading of the entire frame with emphasis placed on the center. • Suitable for photos with subjects in the center of the frame.

Selecting a White Balance setting P M

The color of your photo depends on the type and quality of the light source. If you want the color of your photo to be realistic, select a White Balance setting that is appropriate for the lighting conditions, such as Auto WB, Daylight, Cloudy, or Tungsten.



 Auto WB



 Daylight











 Cloudy





 Tungsten

- 1 In Shooting mode, press [MENU].
- 2 Select **White Balance**.
- 3 Select an option.

Icon	Description
	Auto WB: Automatically set the White Balance based on the lighting conditions.
	Daylight: For outdoor photos on a sunny day.
	Cloudy: For outdoor photos on a cloudy day or in shadows.
	Fluorescent_H: For shooting under a daylight fluorescent or 3-way fluorescent light.
	Fluorescent_L: For shooting under white fluorescent light.
	Tungsten: For shooting indoor photos under incandescent bulbs or halogen lamps.
	Custom Set: To use White Balance settings that you define. (p. 74)
	Color Temp.: To adjust the color temperature of the light source. (p. 74)

Customizing preset White Balance options

You can customize preset White Balance options except **Auto WB** and **Custom Set**.

- 1 In Shooting mode, press [MENU].
- 2 Select **White Balance**.
- 3 Scroll to a desired option.
- 4 Press [DISP].
- 5 Press [DISP/] to adjust the value on the coordinates.
 - You can also touch an area on the screen.

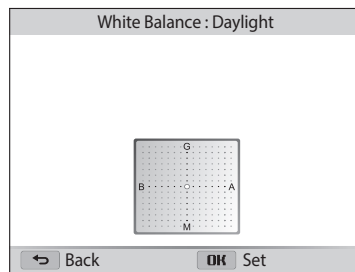

- **G:** Green
- **A:** Amber
- **M:** Magenta
- **B:** Blue

- 6 Press [OK] to save your settings.

Defining your own White Balance

You can customize the White Balance by capturing a photo of a white surface, such as a piece of paper, under the lighting conditions in which you intend to capture a photo. The White Balance feature will help you to match the colors in your photo with the actual scene.

- 1 In Shooting mode, press [MENU].
- 2 Select **White Balance** → **Custom Set**.
- 3 Aim the lens at a piece of white paper, and then press [Shutter].

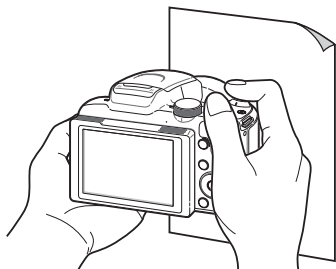

Adjusting color temperature

- 1 In Shooting mode, press [MENU].
- 2 Select **White Balance** → **Color Temp.**.
- 3 Press [**⚡/☀️**] to adjust the color temperature to match your light source.
 - You can capture a warmer photo with a higher color temperature setting (more yellow/red), and a cooler photo with a lower color temperature setting (more blue).

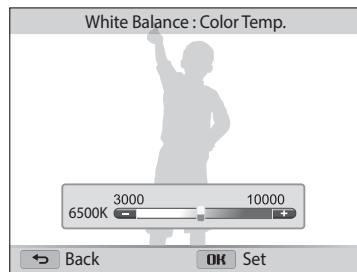

- 4 Press [OK] to save your settings.





Using burst modes (Continuous/Precapture/Bracket) P M

It can be difficult to capture photos of fast-moving subjects or capture natural facial expressions and gestures of your subjects in photos. Also, it can be difficult to adjust the exposure correctly and select a proper light source. In these cases, select one of the burst modes.



Capturing continuous photos

- 1 In Shooting mode, press [Q].
- 2 Select an option.

Icon	Description
	Continuous (8 fps): Capture 8 photos per second continuously. (You can capture up to 7 photos in one burst.)
	Continuous (5 fps): Capture 5 photos per second continuously. (You can capture up to 7 photos in one burst.)
	Continuous (3 fps): Capture 3 photos per second continuously. (You can capture up to 7 photos in one burst.)
	Single: Capture a single photo. (Single is not a burst option.)

- 3 Align your subject in the frame, and then half-press [**Shutter**] to focus.
 - 4 Press and hold [**Shutter**].
 - While you are pressing [**Shutter**], the camera captures photos continuously.
- 
 - You can use the Face Detection, flash, timer, and ACB only when you select **Single**.
 - Depending on the Face Detection option you selected, some Burst options may not be available.
 - It may take longer to save the photos depending on the memory card capacity and performance.
 - In some modes, you can also set a burst option by pressing [**MENU**], and then selecting **Drive/Timer**.

Capturing photos in the Precapture mode



In Precapture mode, the camera starts shooting before you even press the shutter all the way down. If you do not want to miss the first couple of important shots, simply use this mode and select the photo with the best results after shooting.

- 1 In Shooting mode, press .
- 2 Select **Precapture**.
- 3 Align your subject in the frame, and then half-press [**Shutter**] to focus.
 - The camera captures 6 photos continuously. If you release [**Shutter**] too fast, the camera captures less than 6 photos.
- 4 Press [**Shutter**].
 - The camera captures the last photo and then saves all of the captured photos while you are half-pressing [**Shutter**]. (total 7 photos)
 - If you do not press [**Shutter**] all the way down, the photos captured while you are half-pressing [**Shutter**] will not be saved.

Capturing bracketed photos

You can use the automatic bracketing feature to capture multiple photos of the same subject with different setting values slightly modified, such as exposure or white balance.

- 1 In Shooting mode, press .
- 2 Select a bracketing option.

Icon	Description
	AE Bracket: Capture 3 photos with different exposures : normal, underexposed, and overexposed.
	WB Bracket: Capture 3 photos with different white balance.

- 3 Align your subject in the frame, and then half-press [**Shutter**] to focus.
- 4 Press [**Shutter**].
 - The camera captures 3 photos continuously.



- In some modes, you can also set a detailed option by pressing [**MENU**], and then selecting **Bracket Set**.
- It may take longer to capture the photo. Use a tripod for best results.

Selecting a bracketing option

- 1 In Shooting mode, press **[MENU]**.
- 2 Select **Bracket Set**.
- 3 Select a bracketing option.
- 4 Press **[DISP/↓]** to select a detailed option.
 - Adjust the color for the selected light source (white balance) or select an exposure value.
- 5 Press **[OK]** to save your settings.



Adjusting images P M

Adjust the sharpness, contrast, or saturation of your photos.

- 1 In Shooting mode, press [MENU].
- 2 Select **Image Adjust**.
- 3 Select an option.
 - Sharpness
 - Contrast
 - Saturation

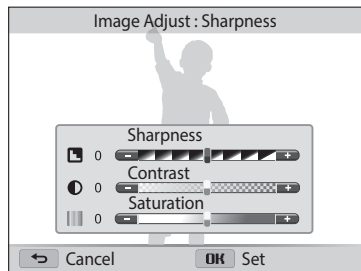

- 4 Press [/] to adjust each value.

Sharpness	Description
-	Soften the edges on your photos (suitable for editing the photos on your computer).
+	Sharpen the edges to improve the clarity of your photos. This may also increase the noise in your photos.

Contrast	Description
-	Decrease the color and brightness.
+	Increase the color and brightness.

Saturation	Description
-	Decrease the saturation.
+	Increase the saturation.

- 5 Press [OK] to save your settings.





Select 0 if you do not want to apply any effects (suitable for printing).

Reducing the sound of the zoom

AUTO P M SCN ★ 📷

When you use the zoom while recording videos, the camera can record the sound of the zoom. Use the Zoom Mute function not to record zoom noise.

- 1 In Shooting mode, press [MENU].
- 2 Select **Voice**.
- 3 Select an option.

Icon	Description
	Zoom Mute: The camera stops recording sound temporarily when you use the zoom.
	Off: Record a video without sound.
	On: Record a video with sound.



- Do not block the microphone when you use the Voice function.
- Recordings made with Voice may differ from actual sounds.

Playback/Editing

Learn how to play back photos or videos, and edit photos or videos. Also, learn how to connect your camera to your computer or TV.

Viewing photos or videos in Playback mode ...	81	Viewing files on a TV or HDTV	95
Starting Playback mode	81	Transferring files to the computer	97
Viewing photos	86	Transferring files to your Windows OS	
Playing a video	89	computer	97
Editing a photo	91	Transferring files to your Mac OS computer	98
Resizing photos	91	Using programs on the computer	99
Rotating a photo	91	Installing i-Launcher	99
Applying Smart Filter effects	92	Using i-Launcher	100
Adjusting your photos	93		

Viewing photos or videos in Playback mode

Learn how to play back photos or videos and how to manage files.

Starting Playback mode

View photos or play videos stored in your camera.

- 1 Press [▶].
 - The most recent file will be displayed.
 - If the camera is off, it will turn on and display the most recent file.
- 2 Press [⚡/📷] to scroll through files.
 - Press and hold [⚡/📷] to scroll through files quickly.



- If you want to view files stored in the internal memory, remove your memory card.
- You may not be able to edit or play back files that were captured with other cameras, due to unsupported sizes (image size, etc) or codecs. Use a computer or another device to edit or play back these files.
- Photos or videos captured in portrait orientation do not rotate automatically and are displayed in landscape orientation by the camera and other devices.

Photo file information

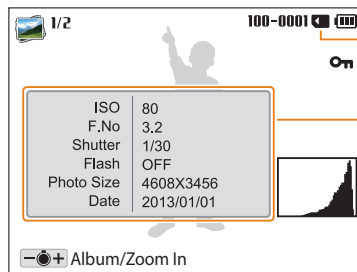

Memory in use

File Information

Histogram

Icon	Description
1/2	Current file/Total files
100-0001	Folder name–File name
H5	Photo captured in a Continuous burst mode or in Precapture mode (See Viewing files as a folder, p. 84)
On	Protected file



To display file information on the screen, press [DISP].

Video file information

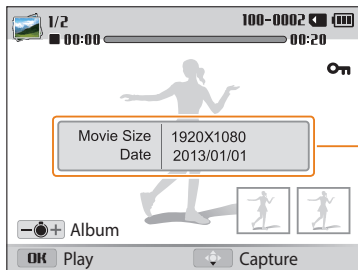

File Information

Icon	Description
1/2	Current file/Total files
100-0002	Folder name-File name
00:00	Current playback time
00:20	Video length
On	Protected file
	Image captured while recording a video (up to 6 photos)



To display file information on the screen, press [DISP].

Viewing files as thumbnails

Scan thumbnails of files.

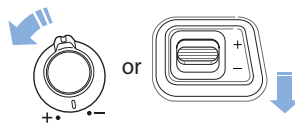

In Playback mode, rotate **[Zoom]** to the left to view thumbnails (12 at a time). Rotate **[Zoom]** to the left once more to display more thumbnails (24 at a time). Rotate **[Zoom]** to the right to return to the previous view.

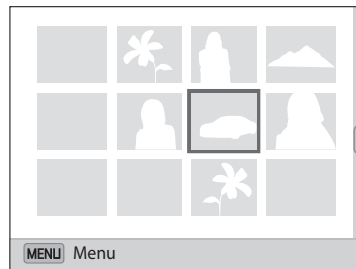

Press [DISP///] to scroll through files.

Viewing files by category

View files by category, such as date or file type.

- 1 In Playback mode, rotate **[Zoom]** to the left.
- 2 Press **[MENU]**.
- 3 Select **Filter** → a category.

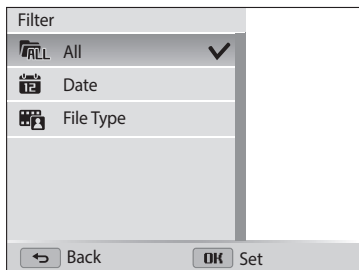

Icon	Description
	All: View files normally.
	Date: View files by the date they were saved.
	File Type: View files by the file type.

- 4 Scroll to a desired list, and then press **[OK]** to open the list.
- 5 Scroll to a desired file, and then press **[OK]** to view the file.
- 6 Rotate **[Zoom]** to the left to return to the previous view, and then press **[↵]**.



- If you change the category, it may take some time for the camera to reorganize files depending on the number of files.
- If you delete a category classified by **Date** or **File Type**, all files in the category will be deleted.

Viewing files as a folder

Photos captured in a Continuous mode or in Precapture mode appear as a folder.

- 1 In Playback mode, press [**⚡/📷**] to scroll to a desired folder.
 - The camera will automatically play back photos in the folder.

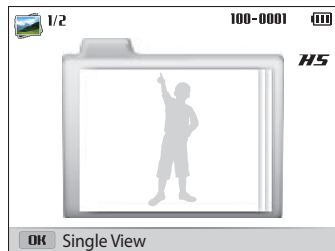

- 2 Press [**OK**] to open the folder.
- 3 Press [**⚡/📷**] to scroll through the files.
- 4 Press [**OK**] or rotate [**Zoom**] to the left to return to Playback mode.

Protecting files

Protect a file from accidental deletion.

- 1 In Playback mode, select a file to protect.
- 2 Press [**MENU**], and then select **Protect** → **On**.
- 3 Repeat steps 1 and 2 to protect additional files.



You cannot delete, resize, or rotate a protected file.

Deleting files

Select files to delete in Playback mode.

Deleting a single file

You can select one file, and then delete it.

- 1 In Playback mode, select a file, and then press [Fn].
- 2 When the pop-up message appears, select **Yes**.



You can also delete files in Playback mode by pressing [MENU], and then selecting **Delete** → **Delete** → **Yes**.

Deleting multiple files

You can select multiple files, and then delete them at once.

- 1 In Playback mode, press [Fn].
 - When in thumbnails view, press [MENU], select **Delete** → **Select**, and then skip to step 3, or press [Fn], select **Select**, and then skip to step 3.
- 2 When the pop-up message appears, select **Multiple Delete**.
- 3 Scroll to each file you want to delete, and then press [OK].
 - Press [OK] again to cancel your selection.
- 4 Press [Fn].
- 5 When the pop-up message appears, select **Yes**.

Deleting all files

You can select all files, and then delete them at once.

- 1 In Playback mode, press [**MENU**].
 - When in thumbnails view, press [**MENU**], select **Delete** → **Delete All**, and then skip to step 3, or press [**Fn**], select **Delete All**, and then skip to step 3.
- 2 Select **Delete** → **Delete All**.
- 3 When the pop-up message appears, select **Yes**.
 - All unprotected files are deleted.

Copying files to a memory card

Copy files from the internal memory to a memory card.

- 1 In Playback mode, press [**MENU**].
- 2 Select **Copy to Card**.

Viewing photos

Enlarge part of a photo or view photos as a slide show.

Enlarging a photo

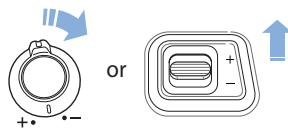

In Playback mode, rotate [**Zoom**] to the right to enlarge a portion of the photo. Rotate [**Zoom**] to the left to zoom out.

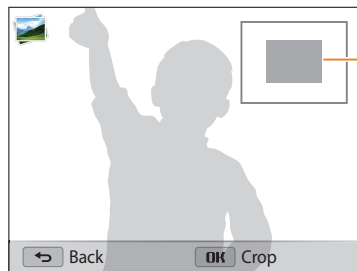

To	Description
Move the enlarged area	Press [DISP/🌿/⚡/📷].
Trim the enlarged photo	Press [OK], and then select Yes . (The trimmed photo will be saved as a new file. The original photo is retained in its original form.)



When you view photos that were captured by another camera, the zoom ratio may differ.

Viewing panoramic photos

View photos captured in Panorama mode.

- In Playback mode, press [⚡/📷] to scroll to a desired panoramic photo.
 - The entire panoramic photo appears on the screen.
- Press [OK].
 - The camera automatically scrolls through the photo from left to right for a horizontal panoramic photo and from top to bottom for a vertical panoramic photo. The camera then switches to Playback mode.
 - While playing back a panoramic photo, press [OK] to pause or resume from pausing.
 - After you have paused the playback of a panoramic photo, press [DISP/🌿/⚡/📷] to move the photo horizontally or vertically, depending on the direction you moved when capturing the photo.
- Press [↩] to return to Playback mode.



The camera automatically scrolls through the panoramic photo only if the longest side of the photo is two or more times longer than the shortest side.

Playing a slide show

Apply effects and audio to a slide show of your photos. The slide show function does not work for videos.

- 1 In Playback mode, press [MENU].
- 2 Select **Slide Show Options**.
 - Skip to step 5 to start a slide show with no effects.
- 3 Select a slide show effect option.

* Default

Option	Description
Play Mode	Set whether or not to repeat the slide show. (One Play* , Repeat)
Interval	<ul style="list-style-type: none"> • Set the interval between photos. (1 sec*, 3 sec, 5 sec, 10 sec) • You must set the Effect option to Off to set the interval.
Music	Set background audio.
Effect	<ul style="list-style-type: none"> • Set a scene change effect between photos. (Off, Calm*, Relax, Lively, Sweet, Shine) • Select Off to cancel effects. • When you use the Effect option, the interval between photos will be set to 1 second.

- 4 Press [MENU].
- 5 Select **Start Slide Show**.
- 6 View the slide show.
 - Press [OK] to pause the slide show.
 - Press [OK] again to resume the slide show.



- Press [OK], and then press [⚡/🔊] to stop the slide show and return to Playback mode.
- Rotate [Zoom] to the left or right to adjust the volume level.

Playing a video

In Playback mode, you can view a video, and then capture or trim parts of the playing video. You can save the captured or trimmed segments as new files.

- 1 In Playback mode, select a video, and then press [OK].
- 2 View the video.

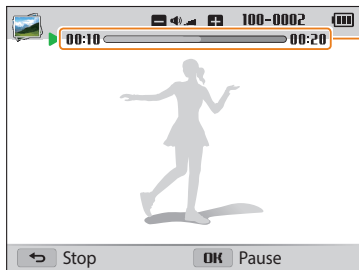

Current playback time/
Video length

To	Description
Scan backward	Press [⏮]. Each time you press [⏮], you change the scan speed in this order: 2X, 4X, 8X.
Pause or resume playback	Press [OK].
Scan forward	Press [⏭]. Each time you press [⏭], you change the scan speed in this order: 2X, 4X, 8X.
Adjust the volume level	Rotate [Zoom] to the left or right.



You can scan backwards or forwards or pause the video after at least 2 seconds have elapsed from the starting point.

Trimming a video

- 1 In Playback mode, select a video, and then press [MENU].
- 2 Select **Trim Movie**.
- 3 Press [OK] to start playing the video.
- 4 Press [OK] → [👉] at the point where you want the trimming to begin.
- 5 Press [OK] to resume playing the video.
- 6 Press [OK] → [👉] at the point where you want the trimming to end.
- 7 Press [👉] to trim.
- 8 When the pop-up message appears, select **Yes**.



- The original video should be at least 10 seconds long.
- The camera will save the edited video as a new file and leave the original video intact.

Capturing an image from video

- 1 While viewing a video, press [OK] at the point where you want to capture an image.
- 2 Press [👉].



- The resolution of the captured image will be the same as the original video.
- The captured image is saved as a new file.

Editing a photo

Learn how to edit photos.



- The camera will save edited photos as new files.
- When you edit photos, the camera will automatically convert them to a lower resolution. Photos that you rotate or resize manually are not automatically converted to a lower resolution.
- You cannot edit a photo while viewing a folder. To edit a photo in a folder, press [OK] to open the folder, and then scroll to the photo.

Resizing photos

Change the size of a photo and save it as a new file.

- 1 In Playback mode, select a photo, and then press [MENU].
- 2 Select **Resize**.
- 3 Select an option.

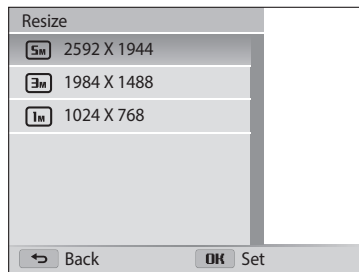

Available resize options differ depending on the original size of the photo.

Rotating a photo

- 1 Rotate the mode dial to .
- 2 Select .
- 3 Rotate [Zoom] to the left, and then select a photo.
- 4 Select **Rotate** → an option.

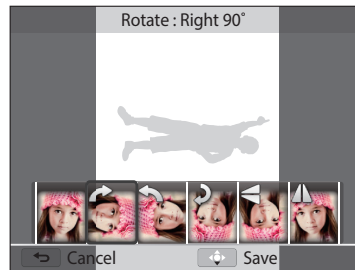



- 5 Press [] to save.



- The camera will overwrite the original file.
- In Playback mode, press [MENU], and then select **Rotate** to rotate a photo.

Applying Smart Filter effects

Apply special effects to your photos.

- 1 Rotate the mode dial to .
- 2 Select .
- 3 Rotate [Zoom] to the left, and then select a photo.
- 4 Select **Smart Filter** → an option.



Option	Description
Normal	No effect
Miniature	Apply a tilt-shift effect to make the subject appear in miniature. (The top and bottom of the photo will be blurred.)
Vignetting	Apply the retro-looking colors, high contrast, and strong vignette effect of Lomo cameras.
Cross Filter	Add lines that radiate outward from bright objects to imitate the visual effect of a cross filter.
Fish-eye	Distort close objects to imitate the visual effect of a fisheye lens.
Classic	Apply a black and white effect.
Retro	Apply a sepia tone effect.

- 5 Press [] to save.



Adjusting your photos



Learn how to adjust the brightness, contrast, or saturation or how to correct the red-eye effect. If the center of a photo is dark, you can adjust it to be brighter. The camera will save an edited photo as a new file, but may convert it to a lower resolution.





- You can adjust brightness, contrast, and saturation and apply Smart Filter effects at the same time.
- You cannot apply the ACB, Face Retouch, and Red-eye Fix effects at the same time.



Adjusting brightness, contrast, or saturation

- 1 Rotate the mode dial to .
- 2 Select .
- 3 Rotate [**Zoom**] to the left, and then select a photo.
- 4 Select an adjusting option.





Icon	Description
	Brightness
	Contrast
	Saturation

- 5 Press [/] to adjust the option.
- 6 Press [**OK**].
- 7 Press [] to save.



Adjusting dark subjects (ACB)

- 1 Rotate the mode dial to .
- 2 Select .
- 3 Rotate [**Zoom**] to the left, and then select a photo.
- 4 Select **ACB**.
- 5 Press [] to save.

Retouching faces

- 1 Rotate the mode dial to .
- 2 Select .
- 3 Rotate [**Zoom**] to the left, and then select a photo.
- 4 Select **Face Retouch**.
- 5 Press [/] to adjust the option.
 - As the number increases, the skin tone becomes brighter and smoother.
- 6 Press [] to save.

Removing red-eye

- 1 Rotate the mode dial to .
- 2 Select .
- 3 Rotate [**Zoom**] to the left, and then select a photo.
- 4 Select **Red-eye Fix**.
- 5 Press [] to save.

Viewing files on a TV or HDTV

Play back photos or videos by connecting your camera to a TV with the A/V cable.

- 1 Rotate the mode dial to .
- 2 Select **Connectivity** → **Video Out**.
- 3 Select the video signal output for your country or region. (p. 107)
- 4 Turn off your camera and TV.
- 5 Connect your camera to your TV with the A/V cable.

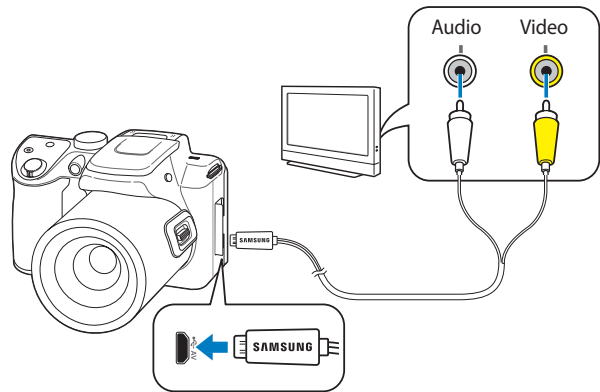

- 6 Turn on your TV, and then select the A/V video source.
- 7 Turn on your camera.
 - The camera automatically enters into Playback mode when you connect it to a TV.
- 8 View photos or play videos using the camera buttons.



- Depending on the TV model, you may see some digital noise or part of an image may not appear.
- Images may not be centered on the TV screen depending on your TV settings.

Viewing files on an HDTV

You can view high-quality and uncompressed photos or videos on an HDTV using the optional HDMI cable. HDMI (High Definition Multimedia Interface) is supported by most HDTVs.

- 1 Rotate the mode dial to .
- 2 Select **Connectivity** → **HDMI Size**.
- 3 Select an HDMI resolution. (p. 107)
- 4 Turn off your camera and HDTV.
- 5 Connect your camera to your HDTV with the optional HDMI cable.

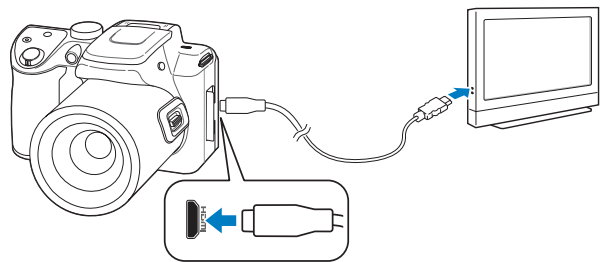

6 Turn on your camera.

- If you have an Anynet+ compatible Samsung HDTV and you have turned on your camera's Anynet+ function, the HDTV turns on automatically and displays the camera screen, while the camera automatically enters Playback mode.
- If Anynet+ is off in your camera or your TV does not have Anynet+, the TV does not turn on automatically. Turn the TV on manually.

7 View files using the buttons on your camera or, if the TV has Anynet+, the remote control of your HDTV.



- If your HDTV supports the Anynet+(CEC) profile, turn Anynet+ on in the camera's settings menu (p. 107) to control the camera and TV with the TV's remote control.
- Anynet+ lets you control all connected Samsung A/V devices with the TV remote control.
- The time it takes for the camera to connect to your HDTV may vary with the type of SD, SDHC, or SDXC card you use. A faster SD, SDHC, or SDXC card will not necessarily result in a faster HDMI transfer, because the main function of the card is to improve the transfer rate during shooting.

Transferring files to the computer

Connect the camera to the computer, to transfer files from the camera's memory card to the computer.

Transferring files to your Windows OS computer

Connect the camera to your computer as a removable disk.



Your computer must be running Windows XP, Windows Vista, Windows 7, or Windows 8 for you to connect the camera as a removable disk.

- 1 Rotate the mode dial to **⚙️**.
- 2 Select **Connectivity** → **i-Launcher** → **Off**.
- 3 Turn off the camera.
- 4 Connect the camera to your computer with the USB cable.



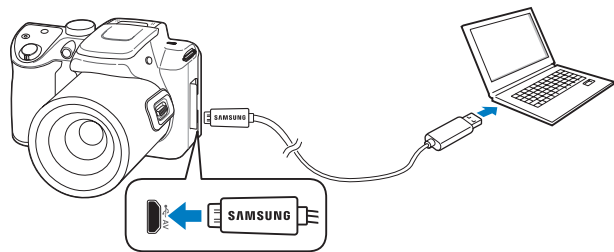

You must plug the small end of the USB cable into your camera. If the cable is reversed, it may damage your files. The manufacturer is not responsible for any loss of data.



- 5 Turn on the camera.
 - The computer recognizes the camera automatically.
- 6 On your computer, select **My Computer** → **Removable Disk** → **DCIM** → **100PHOTO**.
- 7 Drag or save files to your computer.

Disconnecting the camera (for Windows XP)

With Windows Vista, Windows 7 and Windows 8 the methods for disconnecting the camera are similar.

- 1 If the status lamp on your camera is blinking, wait until it stops.
 - 2 Click  on the tool bar at the bottom right of your computer screen.
- 
- 3 Click the pop-up message.
 - 4 Click the message box that indicates the camera can be removed safely.
 - 5 Remove the USB cable.

Transferring files to your Mac OS computer

When you connect the camera to your Mac OS computer, the computer will automatically recognize the device. You can transfer files directly from the camera to the computer without installing any programs.



Mac OS 10.5 or later (except PowerPC) is supported.

- 1 Turn off the camera.
- 2 Connect your camera to your Mac OS computer with the USB cable.



You must plug the small end of the USB cable into your camera. If the cable is reversed, it may damage your files. The manufacturer is not responsible for any loss of data.

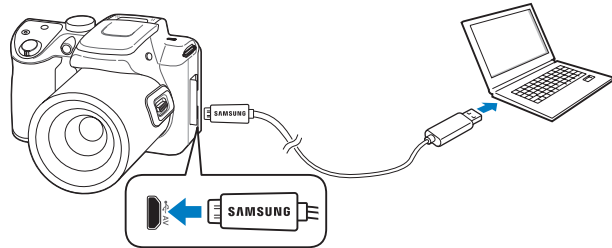

- 3 Turn on the camera.
 - The computer recognizes the camera automatically and displays a removable disk icon.
- 4 Double-click the removable disk icon.
- 5 Drag or save files to your computer.

Using programs on the computer

i-Launcher allows you to playback files with Multimedia Viewer and provides links so that you can download useful programs.

Installing i-Launcher

- 1 Rotate the mode dial to **⚙️**.
- 2 Select **Connectivity** → **i-Launcher** → **On**.
- 3 Turn off the camera.
- 4 Connect the camera to your computer with the USB cable.



You must plug the small end of the USB cable into your camera. If the cable is reversed, it may damage your files. The manufacturer is not responsible for any loss of data.

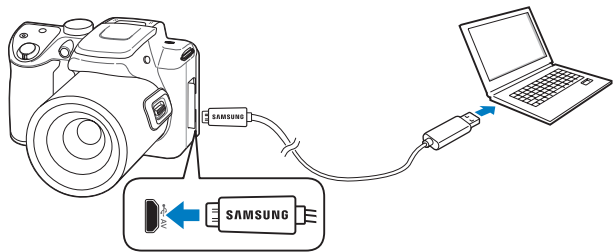

- 5 Turn on the camera.
- 6 Select a destination folder on your computer, and then select **Yes**.
 - If a pop-up window prompting you to run iLinker.exe appears, run it first.
 - When you connect the camera to a computer with i-Launcher installed, the program will launch automatically.
- 7 Follow the on-screen instructions to complete the installation.
 - An i-Launcher shortcut will appear on the computer.



- Before installing the program, ensure that the PC is connected to a network.
- If you use the Mac OS computer, the i-Launcher function is not available.

Available programs when using i-Launcher

Option	Description
Multimedia Viewer	You can view files with Multimedia Viewer.

Using i-Launcher

i-Launcher allows you to play back files with Multimedia Viewer.



- The requirements are recommendation only. i-Launcher may not work properly even when the computer meets the requirements, depending on the condition of your computer.
- If your computer does not meet the requirements, videos may not play correctly.



The manufacturer is not responsible for any damage that results from using unqualified computers such as a computer you assembled yourself.

Windows OS Requirements

Item	Requirements
CPU	Intel Core 2 Duo® 2.0 GHz or higher/ AMD Phenom 2.4 GHz or higher
RAM	Minimum 512 MB RAM (1 GB or more recommended)
OS*	Windows XP SP2, Windows Vista, Windows 7, or Windows 8
Hard disk capacity	250 MB or more (1 GB and above recommended)
Others	<ul style="list-style-type: none">• 1024 X 768 pixels, 16-bit color display compatible monitor (1280 X 1024 pixels, 32-bit color display recommended)• USB 2.0 port• nVIDIA Geforce 7600GT or higher/ ATI X1600 series or higher• Microsoft DirectX 9.0c or higher

* A 32-bit version of i-Launcher will be installed—even on 64-bit editions of Windows XP, Windows Vista, Windows 7, and Windows 8.

Opening i-Launcher

On your computer, select **Start** → **All Programs** → **Samsung** → **i-Launcher** → **Samsung i-Launcher**.

Using Multimedia Viewer

Multimedia Viewer allows you to play back files. From the Samsung i-Launcher screen, click **Multimedia Viewer**.



- Multimedia Viewer supports the following formats:
 - Videos: MP4 (Video: H.264, Audio: AAC), WMV (WMV 7/8/9), AVI (MJPEG)
 - Photos: JPG, GIF, BMP, PNG, TIFF, MPO
- Files that have been recorded with other manufacturers' devices may not play back smoothly.

Viewing photos



No.	Description
1	File name
2	Enlarged area
3	Histogram
4	Open the selected file.
5	Histogram button
6	Rotate to the left/Rotate to the right.
7	Move to the previous file/Move to the next file.
8	Fit the photo to the screen.
9	View the photo in its original size.
10	Zoom in/Zoom out
11	Switch between 2D and 3D mode.

Viewing Videos



No.	Description
1	File name
2	Adjust the volume.
3	Open the selected file.
4	Move to the next file.
5	Stop
6	Pause
7	Move to the previous file.
8	Progress bar

Settings

Refer to options to configure your camera's settings.

Settings menu	105
Accessing the settings menu	105
Sound	106
Display	106
Connectivity	107
General	108





Settings menu

Learn to configure your camera's settings.

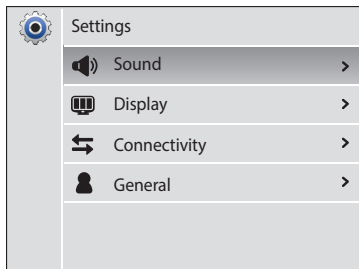
Accessing the settings menu

- 1 Rotate the mode dial to .
- 2 Select a menu.



Icon	Description
	Sound: Set various camera sounds and the volume. (p. 106)
	Display: Customize the display settings. (p. 106)
	Connectivity: Set the connection options. (p. 107)
	General: Change the settings for the camera system such as memory format and default file name. (p. 108)

- 3 Select an item.

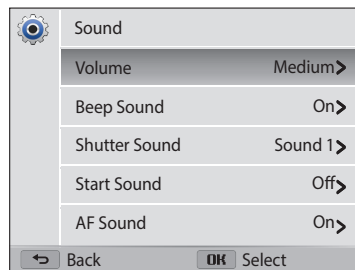

- 4 Select an option.

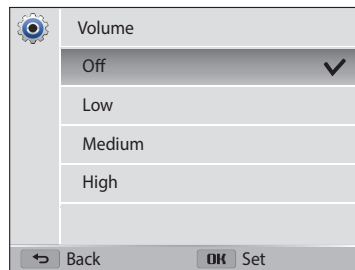

- 5 Press [>] to return to the previous screen.

Sound

* Default



Item	Description
Volume	Set the volume of all sounds. (Off, Low, Medium* , High)
Beep Sound	Set the sound the camera emits when you press the buttons or switch modes. (Off, On*)
Shutter Sound	Set the sound the camera emits when you press the shutter button. (Off, Sound 1* , Sound 2, Sound 3)
Start Sound	Set the sound the camera emits when you turn on your camera. (Off* , Star Flight, Laser Show, Cloud)
AF Sound	Set the sound the camera emits when you half-press the shutter button. (Off, On*)

Display

* Default

Item	Description
Start Image	<p>Set a start image to display when the camera turns on.</p> <ul style="list-style-type: none"> • Off*: Display no start image. • Logo: Display a default image stored in the internal memory. • User Image : Select User Image from the photos you captured in the memory.  <ul style="list-style-type: none"> • The camera will save only one User Image in the internal memory at a time. • If you select a new photo as a User Image or reset your camera, the camera will delete the current image.
Guide Line	Select a guide to help you compose a scene. (Off* , 2 X 2, 3 X 3, Cross, Diagonal)
Date/Time Display	Set whether or not to display the date and time on the camera's display. (Off* , On)
Help Display	Display a brief description of an option or menu. (Off, On*)

* Default

Item	Description
Display Brightness	Adjust the brightness of the screen. (Auto* , Dark , Normal , Bright)  Normal is fixed in Playback mode even if you have selected Auto .
Quick View	Set whether or not to review a captured image before returning to the Shooting mode. (Off , On*)  This feature does not work in some modes.
Auto Display Off	If you perform no operations for 30 seconds, the camera automatically switches to Auto Display Off mode. (Off* , On)  <ul style="list-style-type: none"> In Auto Display Off mode, press any button other than [⏪] to resume using the camera. Even if you do not set the Auto Display Off mode, the screen will dim 30 seconds after the last operation to save power.



Connectivity

* Default

Item	Description
Video Out	Set the video signal output for your region. <ul style="list-style-type: none"> NTSC: USA, Canada, Japan, Korea, Taiwan, Mexico, etc PAL (supports only BDGH!): Australia, Austria, Belgium, China, Denmark, England, Finland, France, Germany, Italy, Kuwait, Malaysia, Netherlands, New Zealand, Norway, Singapore, Spain, Sweden, Switzerland, Thailand, etc
Anynet+ (HDMI-CEC)	Turn on to control the camera with a TV remote control when you connect it to an HDTV that supports the Anynet+(CEC) profile. <ul style="list-style-type: none"> Off: View files without using an HDTV remote control. On*: Control the camera with an HDTV remote control.
HDMI Size	Set the resolution of photos when the camera plays back files on an HDTV via the HDMI cable. (NTSC: 1080i* , 720p , 480p / PAL: 1080i* , 720p , 576p) <ul style="list-style-type: none"> If the HDTV does not support the selected resolution, the HDTV automatically selects the next lower resolution.
i-Launcher	Set i-Launcher to launch automatically when you connect your camera to your computer. (Off , On*)

General



* Default

Item	Description
Language	Set a language for the display text.
Time Zone	Set the time zone for your location. When you travel to another country, select Visit , and then select the appropriate time zone. (Home* , Visit)
Date/Time Set	Set the date and time.
Date Type	Set a date format. (YYYY/MM/DD, MM/DD/YYYY, DD/MM/YYYY)  The default date type may differ depending on the language selected.
Time Type	Set the time format. (12 Hr , 24 Hr)  The default time type may differ depending on the language selected.

* Default

Item	Description
File No.	Specify how to name files. <ul style="list-style-type: none"> • Reset: Set the file number to start from 0001 when you insert a new memory card, format a memory card, or delete all files. • Series*: Set the file number to resume from the previous file number when you insert a new memory card, format a memory card, or delete all files.  <ul style="list-style-type: none"> • The default name of the first folder is 100PHOTO and the default name of the first file is SAM_0001. • The file number increases by one, from SAM_0001 to SAM_9999, each time you take a picture. • The folder number increases by one, from 100PHOTO to 999PHOTO, each time a folder is full. • The maximum number of files that can be stored in one folder is 9,999. • The camera defines file names according to the Design rule for Camera File system (DCF) standard. If you intentionally change file names, the camera may not play back the files.

* Default

Item	Description
Imprint	<p>Set whether or not to display the date and time on captured photos. (Off*, Date, Date & Time)</p>  <ul style="list-style-type: none"> The date and time will be displayed on the bottom right corner of the photo. Some printer models may not print the date and time properly. The photo will not display the date and time if: <ul style="list-style-type: none"> you select Text in SCN mode you select  mode
Auto Power Off	<p>Set the camera to automatically turn off when you perform no operations for a specified period. (Off, 1 min, 3 min*, 5 min, 10 min)</p>  <ul style="list-style-type: none"> Your settings will not change when you replace the battery. The camera will not automatically turn off when the camera is connected to a computer and while you are playing a slide show or videos.
AF Lamp	<p>Set a light to automatically turn on in dark places to help you focus. (Off, On*)</p>

* Default

Item	Description
Format	<p>Format the internal memory and the memory card. Formatting will delete all files, including protected files. (Yes, No)</p>  <p>Errors can occur if you use a memory card formatted by another brand of camera, a memory card reader, or a computer. Please format memory cards in the camera before using them to capture photos.</p>
Reset	<p>Reset menus and shooting options. Date and time, language, and video output settings will not be reset. (Yes, No)</p>
Open Source Licenses	<p>Show the Open source licenses information.</p>

Appendixes

Get information about error messages, specifications, and maintenance.

Error messages	111
Camera maintenance	112
Cleaning your camera	112
Using or storing the camera	113
About memory cards	115
About the battery	118
Before contacting a service center	122
Camera specifications	125
Glossary	129
FCC notice	134
Index	135

Error messages

When the following error messages appear, try these remedies.

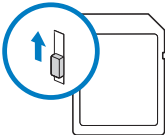
Error message	Suggested remedies
Card Error	<ul style="list-style-type: none">• Turn off your camera, and then turn it on again.• Remove your memory card, and then insert it again.• Format your memory card.
Card Locked	<p>You can lock an SD, SDHC, or SDXC card to prevent files from being deleted. Unlock the card when shooting.</p> 
Card not supported.	The inserted memory card is not supported by your camera. Insert a SD, SDHC, or SDXC memory card.
DCF Full Error	File names do not match the DCF standard. Transfer the files from the memory card to your computer and format the card. Then, open the Settings menu and select General → File No. → Reset. (p. 108)

Error message	Suggested remedies
File Error	Delete the damaged file or contact a service center.
File system not supported.	Your camera does not support the FAT file structure of the inserted memory card. Format the memory card on the camera.
Low Battery	Insert a charged battery or recharge the battery.
Memory Full	Delete unnecessary files or insert a new memory card.
No Image File	Capture photos or insert a memory card that contains some photos.

Camera maintenance

Cleaning your camera

Camera lens and display

Use a blower brush to remove dust and wipe the lens gently with a soft cloth. If any dust remains, apply lens cleaning liquid to a piece of lens cleaning paper and wipe gently.

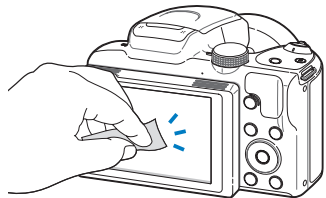
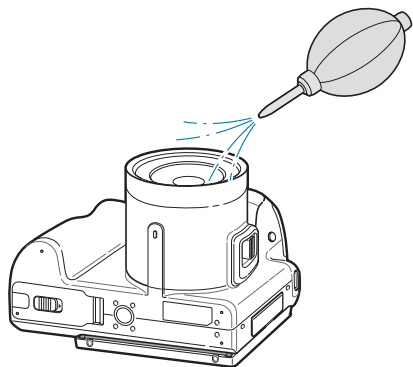

Camera body

Wipe gently with a soft, dry cloth.

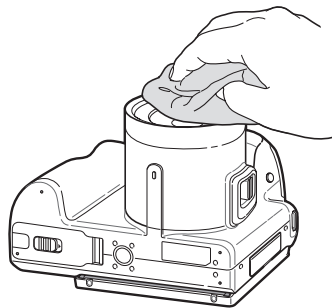

- Never use benzene, thinners, or alcohol to clean the device. These solutions can damage the camera or cause it to malfunction.
- Do not press on the lens cover or use a blower brush on the lens cover.

Using or storing the camera

Inappropriate places to use or store the camera

- Avoid exposing the camera to very cold or very hot temperatures.
- Avoid using your camera in areas with extremely high humidity, or where the humidity changes drastically.
- Avoid exposing the camera to direct sunlight and storing it in hot, poorly-ventilated areas, such as in a car during summer time.
- Protect your camera and the display from impact, rough handling, and excessive vibration to avoid serious damage.
- Avoid using or storing your camera in dusty, dirty, humid, or poorly-ventilated areas to prevent damage to moving parts and internal components.
- Do not use your camera near fuels, combustibles, or flammable chemicals. Do not store or carry flammable liquids, gases, or explosive materials in the same compartment as the camera or its accessories.
- Do not store the camera where there are mothballs.

Using on beaches or shores

- Protect your camera from sand and dirt when you use it on beaches or in similar areas.
- Your camera is not waterproof. Do not handle the battery, adapter, or memory card with wet hands. Operating the camera with wet hands may cause damage to your camera.

Storing for extended period of time

- When you store the camera for an extended period, place it in a sealed container with an absorbent material, such as silica gel.
- Over time, unused batteries will discharge and must be recharged before use.
- The present date and time can be initialized when the camera is turned on after the camera and battery have been separated for a prolonged period.

Using the camera with caution in humid environments

When you transfer the camera from a cold environment to a warm one, condensation can form on the lens or internal components of the camera. In this situation, turn off the camera and wait for at least 1 hour. If condensation forms on the memory card, remove the memory card from the camera and wait until all moisture has evaporated before reinserting it.

Other cautions

- Do not swing your camera by the strap. This may cause injury to yourself or others or damage to your camera.
- Do not paint your camera, as paint can clog moving parts and prevent proper operation.
- Turn off the camera when not using it.
- Your camera contains delicate parts. Avoid impacts to the camera.

- Protect the display from external force by keeping it in the case when not in use. Protect the camera from scratches by keeping it away from sand, sharp implements, or loose change.
- Do not use the camera if the screen is cracked or broken. Broken glass or acrylic could cause injury to your hands and face. Take the camera to a Samsung service center to have it repaired.
- Never place cameras, batteries, chargers, or accessories near, on, or in heating devices, such as microwave ovens, stoves, or radiators. These devices may be deformed and can overheat and cause a fire or explosion.
- Do not expose the lens to direct sunlight, as this may discolor the image sensor or cause it to malfunction.
- Protect the lens from fingerprints and scratches. Clean the lens with a soft, clean, debris-free lens cloth.
- The camera may turn off if struck or dropped. This is to protect the memory card. Turn on the camera to use it again.
- While you use the camera, it may heat up. This is normal and should not affect your camera's lifespan or performance.
- When you use the camera in low temperatures, it may take some time to turn on, the color of the display may be changed temporarily, or after-images may appear. These conditions are not malfunctions and they will correct themselves when the camera is returned to milder temperatures.
- Paint or metal on the outside of the camera may cause allergies, itchy skin, eczema, or swelling for people with sensitive skin. If you experience any of these symptoms, stop using the camera immediately and consult a doctor.
- Do not insert foreign objects into any of your camera's compartments, slots, or access points. Damage due to improper use may not be covered by your warranty.
- Do not allow unqualified personnel to service the camera or attempt to service the camera yourself. Any damage that results from unqualified service is not covered by your warranty.

About memory cards

Supported memory cards

This product supports SD (Secure Digital), SDHC (Secure Digital High Capacity), SDXC (Secure Digital eXtended Capacity), microSD, microSDHC, or microSDXC memory cards.

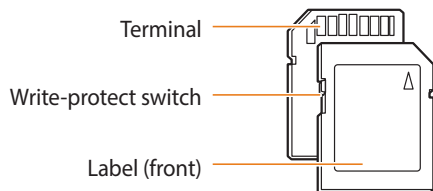

You can prevent files from being deleted by using the write protect switch on an SD, SDHC, or SDXC card. Slide the switch down to lock or slide it up to unlock. Unlock the card when capturing photos and videos.

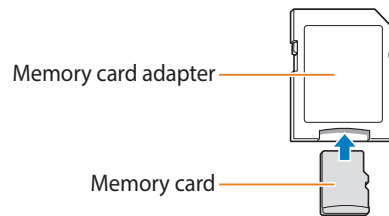









To use micro memory cards with this product, a PC, or a memory card reader, insert the card into an adapter.

Memory card capacity

The memory capacity may differ depending on shooting scenes or shooting conditions. These capacities are based on a 2 GB SD card:

Photo

Size	Super Fine	Fine	Normal
 16M	279	444	630
 14MP	313	481	704
 12M	376	592	814
 10M	438	657	938
 8M	543	849	1,147
 5M	788	938	1,511
 3M	1,140	1,611	1,930
 2M	1,611	2,266	2,744
 1M	2,266	2,744	3,199

Video

Size	60fps	30fps
 1920 X 1080	Approx. 09' 44"	-
HD 1280 X 720	-	Approx. 15' 39"
VGA 640 X 480	-	Approx. 30' 44"
QVGA 320 X 240	-	Approx. 90' 06"

The figures above are measured without using the zoom function. Available recording time may vary if you use the zoom. Several videos were recorded in succession to determine the total recording time.

Cautions when using memory cards

- Avoid exposing memory cards to very cold or very hot temperatures (below 0 °C/32 °F or above 40 °C/104 °F). Extreme temperatures can cause memory cards to malfunction.
 - Insert a memory card in the correct direction. Inserting a memory card in the wrong direction may damage your camera and memory card.
 - Do not use memory cards that have been formatted by other cameras or by a computer. Reformat the memory card with your camera.
 - Turn off the camera before you insert or remove the memory card.
 - Do not remove the memory card or turn off your camera while the lamp is blinking, as this may damage your data.
 - When the lifespan of a memory card has expired, you cannot store any more photos on the card. Use a new memory card.
 - Do not bend, drop, or subject memory cards to heavy impact or pressure.
 - Avoid using or storing memory cards near strong magnetic fields.
 - Avoid using or keeping memory cards in areas with high temperature, high humidity, or corrosive substances.
- Prevent memory cards from making contact with liquids, dirt, or foreign substances. If dirty, wipe the memory card clean with a soft cloth before you insert the memory card into your camera.
 - Do not allow liquids, dirt, or foreign substances to come in contact with memory cards or the memory card slot. Doing so may cause memory cards or the camera to malfunction.
 - When you carry a memory card, use a case to protect the card from electrostatic discharges.
 - Transfer important data to other media, such as a hard disk, CD, or DVD.
 - When you use the camera for an extended period, the memory card may become warm. This is normal and does not indicate a malfunction.



The manufacturer is not responsible for any loss of data.

About the battery

Use only Samsung-approved batteries.

Battery specifications

Specification	Description
Model	SLB-10A
Type	Lithium-ion battery
Cell capacity	1050 mAh
Voltage	3.7 V
Charging time* (when the camera is switched off)	Approximately 240 min

* Charging the battery by connecting it to a computer may take longer.

Battery life

Average shooting time/ Number of photos		Test conditions (when the battery is fully charged)
Photos	Approximately 100 min/ Approximately 200 photos	<p>The battery life was measured under the following conditions: in Program mode, in darkness, 1080p resolution, Fine quality, OIS on.</p> <ol style="list-style-type: none"> 1. Set the flash option to Fill in, take a single shot, and zoom in or out. 2. Set the flash option to Off, take a single shot, and zoom in or out. 3. Perform steps 1 and 2, waiting 30 seconds between each step. Repeat the process for 5 minutes, and then turn off the camera for 1 minute. 4. Repeat steps 1 to 3.
Videos	Approximately 70 min	Record videos at 4K resolution and 60 FPS.

- The figures above are measured by Samsung's standards. Your results may differ, depending on your actual usage.
- Several videos were recorded in succession to determine the total recording time.

Low battery message

When the battery has fully discharged, the battery icon will turn red and the "**Low Battery**" message will appear.

Notes about using the battery

- Avoid exposing batteries to very cold or very hot temperatures (below 0 °C/32 °F or above 40 °C/104 °F). Extreme temperatures can reduce the charging capacity of your batteries.
- When you use the camera for an extended period, the area around the battery chamber may become warm. This does not affect the normal use of the camera.
- Do not pull the power supply cord to disconnect the plug from the power outlet, as this may cause a fire or electric shock.
- In temperatures below 0 °C/32 °F, battery capacity and battery life may decrease.
- Battery capacity may decrease in low temperatures but will return to normal in milder temperatures.
- Remove the batteries from your camera when storing it for an extended period. Installed batteries may leak or corrode over time and cause serious damage to your camera. Storing the camera for extended periods with the battery installed causes the battery to discharge. You may not be able to recharge a fully discharged battery.
- When you do not use the camera for an extended period (3 months or more), check the battery and recharge it regularly. If you let the battery discharge continually, its capacity and life may decrease, which can lead to a malfunction, fire, or explosion.

Cautions about using the battery

Protect batteries, chargers, and memory cards from damage

Prevent batteries from making contact with metal objects, as this can create a connection between the + and – terminals of your battery and lead to temporary or permanent battery damage and may cause a fire or electric shock.

Notes about charging the battery

- If the status lamp is off, make sure that the battery is inserted correctly.
- If the camera is on while charging, the battery may not fully charge. Turn off the camera before charging the battery.
- Do not use your camera when you are charging the battery. This may cause a fire or electric shock.
- Do not pull the power supply cord to disconnect the plug from the power outlet, as this may cause a fire or electric shock.
- Let the battery charge for at least 10 minutes before turning on the camera.
- If you connect the camera to an external power source when the battery is depleted, using high energy-consuming functions will cause the camera to turn off. To use the camera normally, recharge the battery.

- If you reconnect the power cable when the battery is fully charged, the status lamp turns on for approximately 30 minutes.
- Using the flash or recording videos depletes the battery quickly. Charge the battery until the red status lamp turns off.
- If the status lamp blinks in red, reconnect the cable, or remove the battery and insert it again.
- If you charge the battery when the cable is overheated or the temperature is too high, the status lamp may blink in red. Charging will start when the battery cools down.
- Overcharging batteries may shorten battery life. After charging is finished, disconnect the cable from your camera.
- Do not bend or place heavy objects on the AC cable. Doing so may damage the cable.

Notes about charging with a computer connected

- Use only the provided USB cable.
- The battery may not charge when:
 - you use a USB hub
 - other USB devices are connected to your computer
 - you connect the cable to the port on the front side of your computer
 - the USB port of your computer does not support the power output standard (5 V, 500 mA)

Handling and disposing of batteries and chargers with care

- Never dispose of batteries in a fire. Follow all local regulations when you dispose of used batteries.
- Never place batteries or cameras on or in heating devices, such as microwave ovens, stoves, or radiators. Batteries may explode when they are overheated.



Personal injury or death can occur if the battery is handled carelessly or improperly. For your safety, follow these instructions for proper battery handling:

- The battery can ignite or explode if not handled properly. If you notice any deformities, cracks, or other abnormalities in the battery, immediately discontinue use of the battery and contact a service center.
- Use only authentic, manufacturer-recommend battery chargers and adapters and charge the battery only by the methods described in this user manual.
- Do not place the battery near heating devices or expose it to excessively warm environments, such as the inside of an enclosed car in the summertime.
- Do not place the battery in a microwave oven.
- Avoid storing or using the battery in hot, humid places, such as spas or shower enclosures.
- Do not rest the device on flammable surfaces, such as bedding, carpets, or electric blankets for a prolonged period.
- When the device is switched on, do not leave it in any confined space for a prolonged period.
- Do not allow battery terminals to come in contact with metallic objects, such as necklaces, coins, keys, or watches.
- Use only authentic, manufacturer-recommended, Lithium-ion replacement batteries.

- Do not disassemble or puncture the battery with any sharp object.
- Avoid exposing the battery to high pressure or crushing forces.
- Avoid exposing the battery to major impacts, such as dropping it from high places.
- Do not expose the battery to temperatures of 60 °C (140 °F) or above.
- Do not allow the battery to come in contact with moisture or liquids.
- Do not expose the battery to sources of excessive heat such as sunshine, fire or the like.

Disposal guidelines

- Dispose of the battery with care.
- Do not dispose of the battery in a fire.
- Disposal regulations may differ by country or region. Dispose of the battery in accordance with all local and federal regulations.

Guidelines for charging the battery

Charge the battery only by the method described in this user manual. The battery can ignite or explode if not charged properly.

Before contacting a service center

If you are having trouble with your camera, try these troubleshooting procedures before you contact a service center. If you have attempted the suggested remedy and are still having problems with your device, contact your local dealer or service center.



When you leave your camera at a service center, be sure to also leave the other components that may have contributed to the malfunction, such as the memory card and battery.

Situation	Suggested remedies
Cannot turn on the camera	<ul style="list-style-type: none">• Ensure that the battery is inserted.• Ensure that the battery is inserted correctly. (p. 20)• Charge the battery.
The power turns off suddenly	<ul style="list-style-type: none">• Charge the battery.• Your camera may be in Auto Power Off mode. (p. 109)• The camera may turn off to prevent the memory card from being damaged due to an impact. Turn on your camera again.
The camera is losing battery power quickly	<ul style="list-style-type: none">• The battery may lose power more quickly in low temperatures (below 0 °C/32 °F). Keep the battery warm by putting it into your pocket.• Using the flash or recording videos depletes the battery quickly. Recharge if needed.• Batteries are consumable parts that must be replaced over time. Get a new battery if the battery life is diminishing quickly.

Situation	Suggested remedies
Cannot capture photos	<ul style="list-style-type: none">• There is no space on the memory card. Delete unnecessary files or insert a new card.• Format the memory card.• The memory card is defective. Get a new memory card.• Make sure that the camera is switched on.• Charge the battery.• Make sure that the battery is inserted correctly.
The camera freezes	Remove the battery and insert it again.
The camera heats up	While you use the camera, it may heat up. This is normal and should not affect your camera's lifespan or performance.
The flash does not work	<ul style="list-style-type: none">• The flash option may be set to Off. (p. 60)• You cannot use the flash in some modes.

Situation	Suggested remedies
The flash fires unexpectedly	The flash may fire due to static electricity. The camera is not malfunctioning.
The date and time are incorrect	Set the date and time in the display settings. (p. 108)
The display or buttons do not work	Remove the battery, and then insert it again.
The camera display responds poorly	If you use your camera at very low temperatures, it may cause the camera screen to malfunction or discolor. For better performance of your camera screen, use your camera in moderate temperatures.
The memory card has an error	<ul style="list-style-type: none"> • Turn off your camera, and then turn it on again. • Remove your memory card, and then insert it again. • Format your memory card. See "Cautions when using memory cards" for more detail. (p. 117)
Cannot play back files	If you change the name of a file, your camera may not play the file (the name of the file should meet the DCF standard). If you encounter this situation, play back the files on your computer.

Situation	Suggested remedies
The photo is blurry	<ul style="list-style-type: none"> • Make sure that the focus option you set is suitable for close-up shots. (p. 63) • Make sure that the lens is clean. If not, clean the lens. (p. 112) • Make sure that the subject is within range of the flash. (p. 126)
The colors in the photo do not match the actual scene	An incorrect White Balance can create unrealistic color. Select the proper White Balance option to suit the light source. (p. 72)
The photo is too bright	Your photo is overexposed. <ul style="list-style-type: none"> • Turn off the flash. (p. 60) • Adjust the ISO sensitivity. (p. 62) • Adjust the exposure value. (p. 70)
The photo is too dark	Your photo is underexposed. <ul style="list-style-type: none"> • Turn on the flash. (p. 60) • Adjust the ISO sensitivity. (p. 62) • Adjust the exposure value. (p. 70)

Situation	Suggested remedies
The TV does not display your photos	<ul style="list-style-type: none"> • Make sure that the camera is correctly connected to the TV with the A/V cable. • Make sure that your memory card contains photos.
Your computer does not recognize your camera	<ul style="list-style-type: none"> • Make sure that the USB cable is connected correctly. • Make sure that your camera is switched on. • Make sure that you are using a supported operating system.
Your computer disconnects the camera while transferring files	The file transmission may be interrupted by static electricity. Disconnect the USB cable and connect it again.
Your computer cannot play videos	Videos may not play on some video player programs. To play video files captured with your camera, use the Multimedia Viewer program that you can install with the i-Launcher program on your computer.

Situation	Suggested remedies
i-Launcher is not functioning properly	<ul style="list-style-type: none"> • End i-Launcher and restart the program. • Make sure that i-Launcher is set to On in the settings menu. (p. 107) • Depending on your computer's specifications and environment, the program may not launch automatically. In this case, click Start → All Programs → Samsung → i-Launcher → Samsung i-Launcher on your computer. (For Windows 8, click Start → All apps → Samsung i-Launcher.)
Your TV or computer cannot display photos and videos that are stored on a SDXC memory card.	SDXC memory cards use the exFAT file system. Ensure that the external device is compatible with the exFAT file system before connecting the camera to the device.
Your computer does not recognize a SDXC memory card.	SDXC memory cards use the exFAT file system. To use SDXC memory cards on a Windows XP computer, download and update the exFAT file system driver from the Microsoft website.

Camera specifications

Image sensor	
Type	1/2.3" (Approximately 7.77 mm) BSI CMOS
Effective pixels	Approximately 16.38 mega-pixels
Total pixels	Approximately 16.79 mega-pixels
Lens	
Focal length	Samsung Lens f = 4.5–157.5 mm (35 mm film equivalent: 25–875 mm)
F-stop range	F3.0 (W)–F5.9 (T)
Zoom	<ul style="list-style-type: none"> • Still image mode: 1.0–35.0X (Optical zoom X Digital zoom: 70.0X, Optical zoom X Intelli zoom: 70.0X) • Playback mode : 1.0X–14.4X (depending on image size)
Display	
Type	TFT LCD
Feature	3.0" (75.0 mm) 460K
Focusing	
Type	TTL Auto Focus (Center AF, Multi AF, Selection AF, Tracking AF, Face Detection AF)









		Wide (W)	Tele (T)
Range	Normal (AF)	31 in. (80 cm)–infinity	59 in. (150 cm)–infinity
	Macro	4-31 in. (10-80 cm)	59-138 in. (150-350 cm)
	Auto Macro	0.4 in. (1 cm)–infinity	59 in. (150 cm)–infinity
	Super Macro	0.4 in. (1 cm)	
Shutter speed			
<ul style="list-style-type: none"> • Auto: 1/8–1/2,000 sec. • Program: 1–1/2,000 sec. • Night: 8–1/2,000 sec. 			
Exposure			
Control	Program AE		
Metering	Multi, Spot, Center-weighted, Face Detection		
Compensation	±2EV (1/3 EV Step)		
ISO equivalent	Auto, ISO 100, ISO 200, ISO 400, ISO 800, ISO 1600, ISO 3200, ISO 6400		

Flash	
Mode	Off, Auto, Red-eye, Fill in, Slow Sync, Red-eye Fix
Range	<ul style="list-style-type: none"> • Wide: 31-236 in. (80 cm–6 m) (ISO Auto) • Tele: 59-118 in. (1.5 –3 m) (ISO Auto)
Recharging time	Approximately 5 sec.
Shake reduction	
Optical Image Stabilization (OIS)	
Effect	
Photo Shooting mode	<ul style="list-style-type: none"> • Photo Filter (Smart Filter): Miniature, Vignetting, Cross Filter, Fish-eye, Classic, Retro • Image Adjust: Sharpness, Contrast, Saturation
Video Shooting mode	Movie Filter (Smart Filter): Miniature, Vignetting, Fish-eye, Classic, Retro, Palette Effect 1, Palette Effect 2, Palette Effect 3, Palette Effect 4
White Balance	
Auto WB, Daylight, Cloudy, Fluorescent_H, Fluorescent_L, Tungsten, Custom Set, Color Temp.	
Date Imprinting	
Date & Time, Date, Off	

Shooting	
Photos	<ul style="list-style-type: none"> • Modes: Smart Auto (Portrait, Night Portrait, Backlight Portrait, Night, Backlight, Landscape, White, Natural Green, Blue Sky, Sunset, Macro, Macro text, Macro Color, Tripod, Action), Program, Manual, Scene (Frame Guide, Night, Portrait, Children, Landscape, Close up, Text, Sunset, Dawn, Backlight, Fireworks, Beach & Snow), Panorama, Magic Plus (Low Light Shot, HDR, Split Shot, Photo Filter, Movie Filter, Photo Editor) • Burst: Continuous (8fps, 5fps, 3fps), Precapture, Single, Bracket (AE, WB) • Timer: Off, 2 Sec, 10 Sec
Videos	<ul style="list-style-type: none"> • Modes: Smart Scene Detection (Landscape, Blue Sky, Natural Green, Sunset), Movie, Magic Plus (Movie Filter) • Format: MP4 (H.264) (Max recording time: 20 min) • Size: 1920 X 1080, 1280 X 720, 640 X 480, 320 X 240 • High Speed: 360fps(176x128), 240fps(384x288) • Voice: On, Off, Zoom Mute • Capturing during recording • Video editing (embedded): Pause during recording, Still image capture

Camera specifications

Playback	
Photos	<ul style="list-style-type: none"> Type: Single image, Thumbnails, Multi Slide Show with Music and Effect, Movie clip Edit: Resize, Rotate, Smart Filter, Crop Effect: Image Adjust (Brightness, Contrast, Saturation, ACB, Face Retouch, Red-eye Fix), Smart Filter (Normal, Miniature, Vignetting, Cross Filter, Fish-eye, Classic, Retro)
Videos	Edit: Still image capture, Time trimming
Storage	
Media	<ul style="list-style-type: none"> Internal memory: Approximately 74MB External memory (Optional): SD card (2 GB guaranteed), SDHC card (up to 32 GB guaranteed), SDXC card (up to 64 GB guaranteed) Internal memory capacity may not match these specifications.
File format	<ul style="list-style-type: none"> Still Image: JPEG (DCF), EXIF 2.21 Movie Clip: MP4 (Video: MPEG-4.AVC/H.264, Audio: AAC)

Image size	Icon	Size
		4608 X 3456
	4608 X 3072	
	4608 X 2592	
	3648 X 2736	
	2832 X 2832	
	2592 X 1944	
	1984 X 1488	
	1920 X 1080	
	1024 X 768	

Camera specifications

Interface	
Digital output connector	USB 2.0
Audio input/output	Internal speaker (Mono), Microphone (Stereo)
Video output	<ul style="list-style-type: none">• A/V: NTSC, PAL (selectable)• HDMI 1.4: NTSC, PAL (selectable)
DC power input connector	5.0 V
Power source	
Rechargeable battery	Lithium-ion battery (SLB-10A, 1050 mAh)
Connector type	Micro USB (5 pin)

The power source may differ depending on your region.

Dimensions (W X H X D)
4.7 X 3.3 X 2.2 in. (118.9 X 83.8 X 56.5 mm) (without protrusions)
Weight
17.7 oz. (503 g) (without battery and memory card)
Operating Temperature
0–40 °C (32–104 °F)
Operating Humidity
5–85 %
Software
i-Launcher

Specifications may change without notice to improve performance.

Glossary

ACB (Auto Contrast Balance)

This feature automatically improves the contrast of your images when the subject is backlit or when there is a high contrast between your subject and the background.

AEB (Auto Exposure Bracket)

This feature automatically captures several images at different exposures to help you capture a properly-exposed image.

AF (Auto Focus)

A system that automatically focuses the camera lens on the subject. Your camera uses the contrast to focus automatically.

Aperture

The aperture controls the amount of light that reaches the camera's sensor.

Camera shake (Blur)

If the camera is moved while the shutter is open, the entire image may appear blurred. This occurs more often when the shutter speed is slow. Prevent camera shake by raising the sensitivity, using the flash, or using a faster shutter speed. Alternately, use a tripod, the DIS or OIS function to stabilize the camera.

Composition

Composition in photography means arranging objects in a photo. Usually, abiding by the rule of thirds leads to a good composition.

DCF (Design rule for Camera File system)

A specification to define a file format and file system for digital cameras created by the Japan Electronics and Information Technology Industries Association (JEITA).

Depth of field

The distance between the nearest and farthest points that can be acceptably focused in a photograph. Depth of field varies with lens aperture, focal length, and distance from the camera to the subject. Selecting a smaller aperture, for example, will increase the depth of field and blur the background of a composition.

Digital zoom

A feature that artificially increases the amount of zoom available with a zoom lens (Optical zoom). When using the Digital zoom, the image quality will deteriorate as the magnification increases.

DIS (Digital Image Stabilization)

This feature compensates in real-time for shaking and vibrating while shooting. There can be a certain amount of image degradation compare to Optical Image Stabilization.

EV (Exposure Value)

All the combinations of the camera's shutter speed and lens aperture that result in the same exposure.

EV Compensation

This feature allows you to quickly adjust the exposure value measured by the camera, in limited increments, to improve the exposure of your photos. Set the EV compensation to -1.0 EV to adjust the value one step darker and 1.0 EV to one step brighter.

Exif (Exchangeable Image File Format)

A specification to define an image file format for digital cameras created by the Japan Electronic Industries Development Association (JEIDA).

Exposure

The amount of light allowed to reach the camera's sensor. Exposure is controlled by a combination of the shutter speed, the aperture value, and ISO sensitivity.

Flash

A speed light that helps to create adequate exposure in low-light conditions.

Focal length

The distance from the middle of the lens to its focal point (in millimeters). Longer focal lengths result in narrower angles of view and the subject is magnified. Shorter focal lengths result in wider angles of view.

H.264/MPEG-4

A high-compression video format established by international standard organizations ISO-IEC and ITU-T and developed by the Joint Video Team (JVT). This codec is capable of providing good video quality at low bit rates.

Image sensor

The physical part of a digital camera that contains a photosite for each pixel in the image. Each photosite records the brightness of the light that strikes it during an exposure. Common sensor types are CCD (Charge-coupled Device) and CMOS (Complementary Metal Oxide Semiconductor).

ISO sensitivity

The sensitivity of the camera to light, based on the equivalent film speed used in a film camera. At higher ISO sensitivity settings, the camera uses a higher shutter speed, which can reduce blur caused by camera shake and low light. However, images with high sensitivity are more susceptible to noise.

JPEG (Joint Photographic Experts Group)

A lossy method of compression for digital images. JPEG images are compressed to reduce their overall file size with minimal deterioration of the image resolution.

LCD (Liquid Crystal Display)

A visual display commonly used in consumer electronics. This display needs a separate backlight, such as CCFL or LED, to reproduce colors.

Macro

This feature allows you to capture close-up photos of very small objects. When using the macro feature, the camera can maintain a sharp focus on small objects at a near life-size ratio (1:1).

Metering

The metering refers to the way in which the camera measures the quantity of light to set the exposure.

MJPEG (Motion JPEG)

A video format which is compressed as a JPEG image.

Noise

Misinterpreted pixels in a digital image that may appear as misplaced or random, bright pixels. Noise usually occurs when photos are shot with a high sensitivity or when a sensitivity is automatically set in a dark place.

Optical zoom

This is a general zoom which can enlarge images with a lens and does not deteriorate quality of images.

Quality

An expression of the rate of compression used in a digital image. Higher quality images have a lower rate of compression, which usually results in a larger file size.

Resolution

The number of pixels present in a digital image. High resolution images contain more pixels and typically show more detail than low resolution images.

Shutter speed

Shutter speed refers to the amount of time it takes to open and close the shutter, and it is an important factor in the brightness of a photo, as it controls the amount of light which passes through the aperture before it reaches the image sensor. A fast shutter speed allows less time to let light in and the photo becomes darker and more easily freezes subjects in motion.

Vignetting

A reduction of an image's brightness or saturation at the periphery (outer edges) compared to the center of the image. Vignetting can draw interest to subjects positioned in the center of an image.

White balance (color balance)

An adjustment of the intensities of colors (typically the primary colors red, green, and blue), in an image. The goal of adjusting the white balance, or color balance, is to correctly render the colors in an image.



**Correct Disposal of This Product
(Waste Electrical & Electronic Equipment)**

(Applicable in countries with separate collection systems)

This marking on the product, accessories or literature indicates that the product and its electronic accessories (e.g. charger, headset, USB cable) should not be disposed of with other household waste at the end of their working life. To prevent possible harm to the environment or human health from uncontrolled waste disposal, please separate these items from other types of waste and recycle them responsibly to promote the sustainable reuse of material resources.

Household users should contact either the retailer where they purchased this product, or their local government office, for details of where and how they can take these items for environmentally safe recycling.

Business users should contact their supplier and check the terms and conditions of the purchase contract. This product and its electronic accessories should not be mixed with other commercial wastes for disposal.



PlanetFirst represents Samsung Electronics' commitment to sustainable development and social responsibility through eco-driven business and management activities.



Correct disposal of batteries in this product

(Applicable in countries with separate collection systems)

This marking on the battery, manual or packaging indicates that the batteries in this product should not be disposed of with other household waste at the end of their working life. Where marked, the chemical symbols Hg, Cd or Pb indicate that the battery contains mercury, cadmium or lead above the reference levels in EC Directive 2006/66. If batteries are not properly disposed of, these substances can cause harm to human health or the environment.

To protect natural resources and to promote material reuse, please separate batteries from other types of waste and recycle them through your local, free battery return system.

CAN ICES-3 (B)/NMB-3(B)

Dispose unwanted electronics through an approved recycler.
To find the nearest recycling location, go to our website:
www.samsung.com/recyclingdirect Or call, (877) 278 - 0799

Caution:

Any changes or modifications in construction of this device which are not expressly approved by the party responsible for compliance could void the user's authority to operate the equipment.

NOTE:

This equipment has been tested and found to comply with the limits for a Class B digital device, pursuant to part 15 of the FCC Rules. These limits are designed to provide reasonable protection against harmful interference in a residential installation. This equipment generates, uses and can radiate radio frequency energy and, if not installed and used in accordance with the instructions, may cause harmful interference to radio communications. However, there is no guarantee that interference will not occur in a particular installation. If this equipment does cause harmful interference to radio or television reception, which can be determined by turning the equipment off and on, the user is encouraged to try to correct the interference by one or more of the following measures:

- Reorientate or relocate the receiving antenna.
- Increase the distance between the equipment and receiver.
- Connect the equipment into an outlet on a circuit different from that to which the receiver is connected.
- Consult the dealer or an experienced radio/TV technician for help.

• Declaration of Conformity

Trade Name	: Samsung Electronics America, Inc.
Model No.	: Samsung WB2100
Responsible Party	: Samsung Electronics America, Inc.
Address	: 85 Challenger Road, Ridgefield Park, NJ 07660
Telephone No.	: 1-800-SAMSUNG (726-7864)

This device complies with Part 15 of the FCC Rules.

Operation is subject to the following two conditions:

(1) This device may not cause harmful interference, and (2) this device must accept any interference received, including interference that may cause undesired operation.

Index

A

- AF-assist light
 - location 15
 - Settings 109
- AF Lamp 109
- AF Sound 106
- Anynet+ (HDMI-CEC) 107
- Auto Contrast Balance (ACB)
 - Playback mode 93
 - Shooting mode 71
- Auto Display Off 107
- A/V port 15

B

- Battery
 - Caution 119
 - Charging 21
 - Inserting 20
- Blink Detection 68
- Brightness
 - Playback mode 93
 - Shooting mode 70
- Burst modes
 - Bracket 76
 - Continuous 75
 - Precapture 76

C

- Camera maintenance 112
- Camera specifications 125
- Capturing an image from video 90
- Charging 21
- Cleaning
 - Camera body 112
 - Display 112
 - Lens 112
- Connecting to a computer
 - Mac 98
 - Windows 100
- Contrast
 - Playback mode 93
 - Shooting mode 78

D

- Date/Time Set 108
- Deleting files 85
- Digital zoom 34
- Disconnecting the camera 97
- Display brightness 107
- Display type 31

E

- Editing photos 91
- Editing videos
 - Capturing 90
 - Trimming 90
- Enlarging 86
- Error messages 111
- Exposure 70

F

Face Detection 67

Flash

- Auto 61
- Fill in 61
- Off 61
- Red-eye 61
- Red-eye Fix 61
- Slow Sync 61

Focus area

- Center AF 64
- Multi AF 64
- Selection AF 64
- Tracking AF 64

Formatting 109

G

Guide Line 106

H

Half-press shutter 37

HDMI Size 107

HDTV 96

Home screen 26

I

Icons

- Playback mode 81
- Shooting mode 24

i-Launcher 99

Image Adjustment

- ACB 93
 - Brightness
 - Playback mode 93
 - Shooting mode 70
 - Contrast
 - Playback mode 93
 - Shooting mode 78
 - Red-eye 94
 - Saturation
 - Playback mode 93
 - Shooting mode 78
 - Sharpness 78
- Image quality 57**
- Imprint 109**
- Intelli zoom 35**
- ISO sensitivity 62**

L

Language settings 108

M

Macro

- Auto Macro 64
- Macro 64
- Super Macro 64

Magic Plus mode

- HDR 47
- Low Light Shot 47
- Movie Filter 50
- Photo Filter 49
- Split Shot 48

Manual mode 43

Memory card

- Caution 117
- Insert 20

Menu button 17

Metering

- Center-weighted 72
- Multi 72
- Spot 72

Mode dial 17

Movie mode 51

O

Open source licenses 109

Optical Image Stabilization (OIS) 36

Optional accessories 14

P

Panorama mode 45

Playback button 17

Playback mode 81

POWER button 15

Program mode 42

Protecting files 84

Q

Quick view 107

R

REC button 15

Red-eye

- Playback mode 94
- Shooting mode 59

Reset 109

Resolution

- Playback mode 91
- Shooting mode 56

Retouching faces 94

Rotating 91

S

Saturation

- Playback mode 93
- Shooting mode 78

Scene mode 44

Self portrait 67

Service center 122

Settings 108

Sharpness 78

Shooting portraits

- Blink Detection 68
- Face Detection 67
- Red-eye 61
- Red-eye fix 61
- Self portrait 67
- Smile Shot 68

Shutter button 15

Slide show 88

Smart Auto mode 40

Smart Filter

- Photo shooting mode 49
- Playback mode 92
- Video recording mode 50

Smile Shot 68

Sound settings 32

Start Image 106

Status lamp 16

T

Thumbnails 82

Timer

Shooting mode 58

Timer lamp 15

Time settings 22

Time zone settings 22 108

Transferring files

Mac 98

Windows 100

Tripod mount 16

U

Unpacking 14

USB port 15

V

Video

Playback mode 89

Shooting mode 51

Video out 107

Viewing files

Category 83

HDTV 96

Panoramic photos 87

Slide show 88

Thumbnails 82

TV 95

W

White Balance 72

Z

Zoom

Using the zoom 34

Zoom button 16

Zoom sound settings 79



Please refer to the warranty that came with your product or visit our website www.samsung.com for after-sales service or inquiries.

